

# Avantree EON

## User Manual



Model No.: BTHS-AS100



# Contents

EN	User Manual	2
DE	Benutzerhandbuch	18
FR	Manuel de l'utilisateur	34
IT	Manuale utente	50
ES	Manual del usuario	66
JP	取扱説明書	82

# Table of Contents

Box Contents .....	3
Product Introduction .....	4
Product Overview .....	4
Button Functions .....	5
LED Indicators .....	6
Charging the Headphones .....	7
Connecting the Headphones to Your Device .....	8
Pairing & Connecting .....	8
Configuring Audio Settings (only for PC) .....	10
Calling with the Boom Mic .....	12
Using as Wired Headphones .....	13
Replacing the Rechargeable Battery .....	14
Specifications .....	15
FAQ .....	16
Contact Us .....	17

# Box Contents

EN

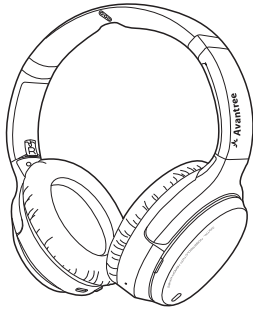

Eon Headphones

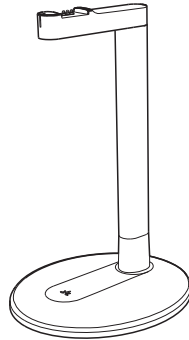

Charging Stand

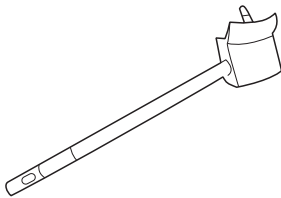

Boom Mic

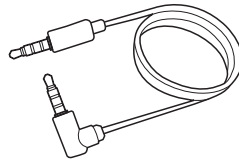

AUX 3.5mm Audio Cable

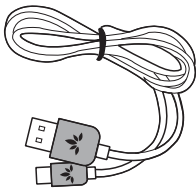

Type C Power Cable

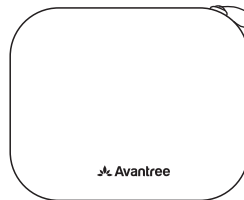

Carrying Case





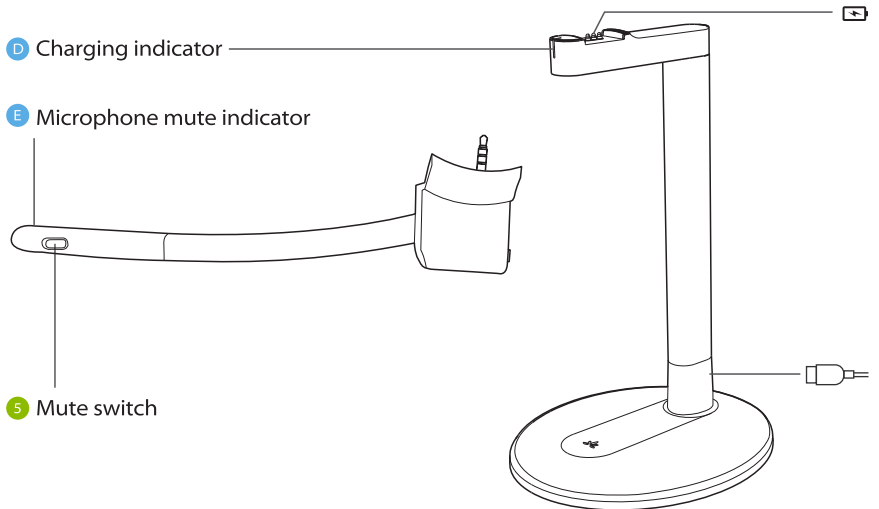
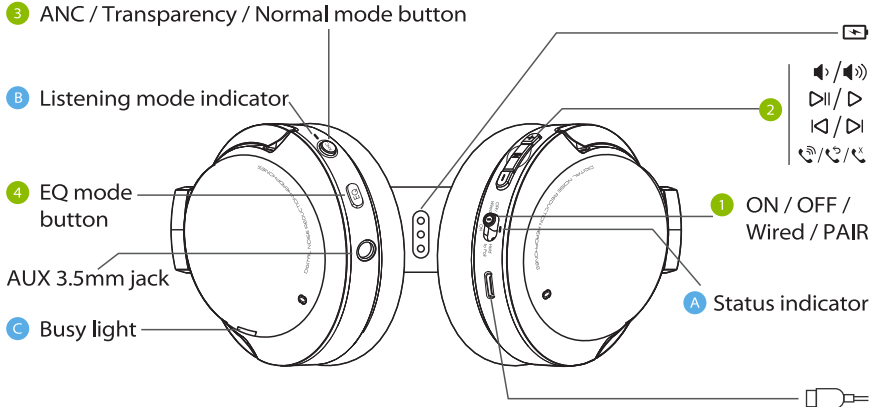



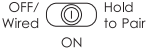

# Product Introduction

## Product Overview



## Button Functions

EN

No.	Button	Functions
1		Switch to the "ON / OFF" position to turn the headphones on / off
		Switch to the "WIRED" position to use as wired headphones
		Switch to the "HOLD TO PAIR" position & hold for 2 seconds to enter pairing mode
2		Press once to play / pause
		Press once to accept / end call
		Press & hold for 2 seconds to reject call
		Press twice to redial last number
		Press once to increase / decrease volume
		Press & hold for 2 seconds to skip / replay track
	Press & hold both "  " & "  " for 1 second to turn sidetone on / off (aka mic monitoring - hear yourself speak)"	
3		Press once to switch between Active Noise Cancellation / Transparency (hear your surroundings) / Normal modes.
4		Press once to switch between balanced and bass-boosted modes
5	 (on boom mic)	Switch to  /  to unmute / mute microphone

## LED Indicators

No.	Indicator & Voice Prompt	Status
A	Solid red	Charging
	Flashing red	Low battery
	Flashing blue, "BATTERY HIGH / MEDIUM / LOW" voice indicator	Power on
	Solid red for 1 second then off, "GOODBYE" voice indicator	Power off
	Alternate red & blue flashes, "PAIRING" voice indicator	Pairing
	Blue flash every 5 seconds, "CONNECTED" voice indicator	Connected
	Blue flash every 2 seconds, "DISCONNECTED" voice indicator	Disconnected
	Solid pink for 5 seconds, then alternate red & blue flashes	Clearing pairing history
B	Solid green, "NOISE CANCELING" voice indicator	Active Noise Cancellation (ANC) mode
	Green flash every 5 seconds, "TRANSPARENCY" voice indicator	Transparency mode
	LED off, "NORMAL" voice indicator	Normal mode
C	Solid red	In a call
D	Solid white	Charging
	Solid green	Charging complete
E	Solid red	Muted microphone



## Charging the Headphones

EN

A “BATTERY LOW” voice prompt and a flashing red **A** light will indicate low battery. In order to charge, you can use either a 5V/500mA-2A rated USB adapter (your phone charger or similar should work) or PC USB port as a power source.

### OPTION 1 Charging with the stand

Place the headphones on the charging stand. The charging dock's LED will turn white while charging and turn green once charging is complete.

### OPTION 2 Charging via USB cable

Alternatively, you can plug the provided type C power cable directly into the headphones' charging port.

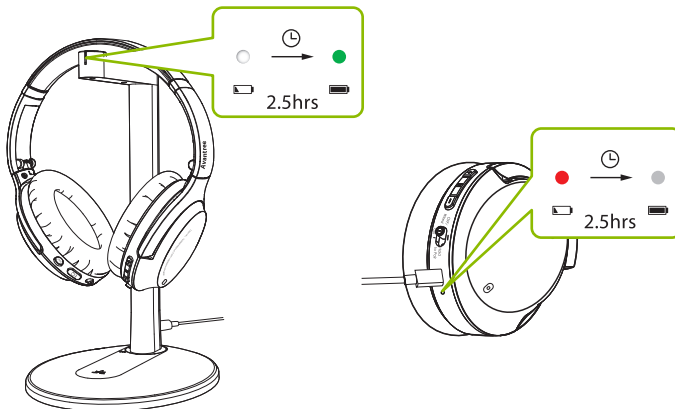

A solid red light indicates that charging is in progress; once the light turns off, your headphones will be at full battery.

# Connecting the Headphones to Your Device

## Pairing & Connecting

### STEP 1

Turn on the headphones. For first time use, the headphones will enter PAIRING mode automatically.

If not, put your headphones into PAIRING mode by sliding the switch to "HOLD TO PAIR" and holding for 2 seconds until the LED flashes red & blue.

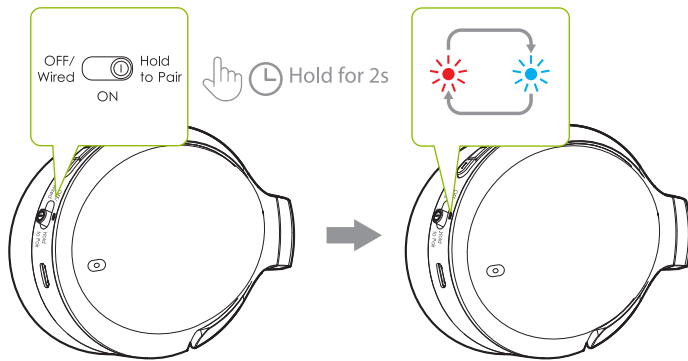
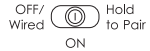



### STEP 2

Turn on your device's Bluetooth and select "Avantree Eon" in the Bluetooth menu.

**STEP 3**

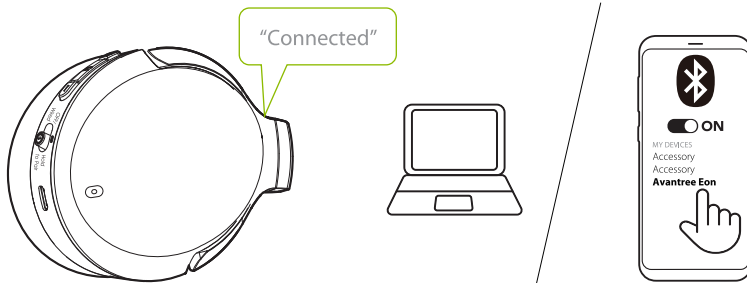
Keep the headphones close to your device and wait for 5-10 seconds or until they connect. Once they're successfully connected, the headphones' LED indicator will flash blue, and you'll hear a "CONNECTED" voice indicator.



For subsequent use, your headphones should automatically reconnect to the last-paired device within a few seconds of being turned on. If not, you can manually activate reconnection by sliding the  switch to "HOLD TO PAIR" once, or by selecting "Avantree Eon" in your device's Bluetooth menu.

## Configuring Audio Settings (only for PC)

You may need to configure your audio settings when using the Eon with your PC or laptop.

### STEP 1

Access your device's audio settings and set "Avantree Eon" as the default in SOUND OUTPUT / PLAYBACK. Set "Avantree Eon" as the default in INPUT / MICROPHONE DEVICE.

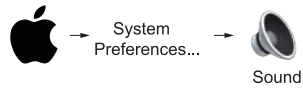
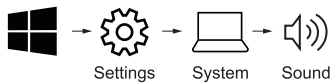

**Sound**

**Output**  
Choose your output device

Avantree Eon ▾

**Input**  
Choose your input device

Avantree Eon ▾

**Sound**

**Output**  
Select a device for sound output:

Avantree Eon

**Input**  
Select a device for sound input:

Avantree Eon

**STEP 2:**

Repeat the above steps in your meeting software (i.e. Teams, Zoom, Skype, etc.)

EN

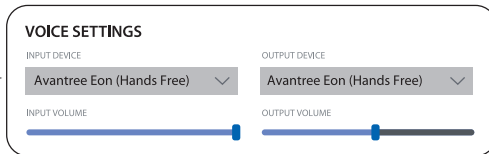
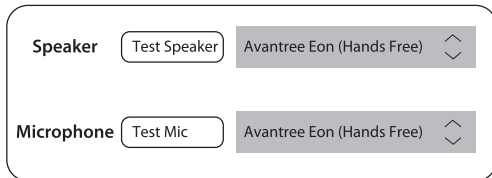
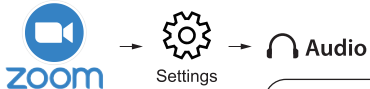
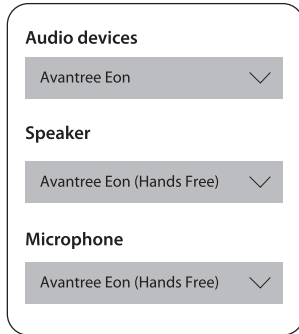
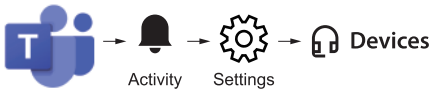

*NOTE: On Windows 11 / macOS, there is no "Hands Free" option; select "Avantree Eon" as the default instead.*

## Calling with the Boom Mic

The Eon headphones themselves have a built-in mic, but using the detachable boom mic will significantly enhance your call quality. Its noise-filtering technology will ensure your voice (and only your voice) is heard loud and clear, and its mute switch can be conveniently utilized.

We highly recommend using the boom mic for your calls. You can use it in both wireless and wired modes by plugging it into the headphones and (optionally) connecting the AUX cable directly to the boom mic.

## Using as Wired Headphones

### STEP 1

Slide the  switch to “OFF / Wired.”

### STEP 2

#### OPTION 1

If you don't need the mic, plug the AUX 3.5mm audio cable into both the headphones and your audio output device.

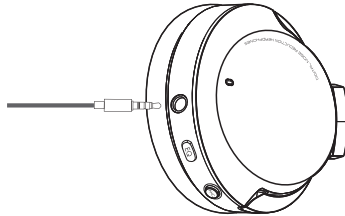

#### OPTION 2

If you'd like to make calls, plug the detachable boom mic into the headphones first, then plug the AUX 3.5mm audio cable into the mic. Plug the other end of the cable into your audio output device.

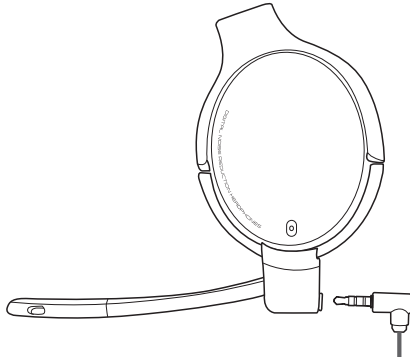

*NOTE: When in wired mode, listening modes (ANC, transparency, normal) and all other built-in buttons do not function. The switch on the boom mic will still work.*

## Replacing the Rechargeable Battery

The rechargeable batteries, located in both headphones ears, can be replaced to extend your Eon's lifespan. Scan the QR code below or search "Avantree Eon battery" on Amazon or the Avantree website in order to purchase.

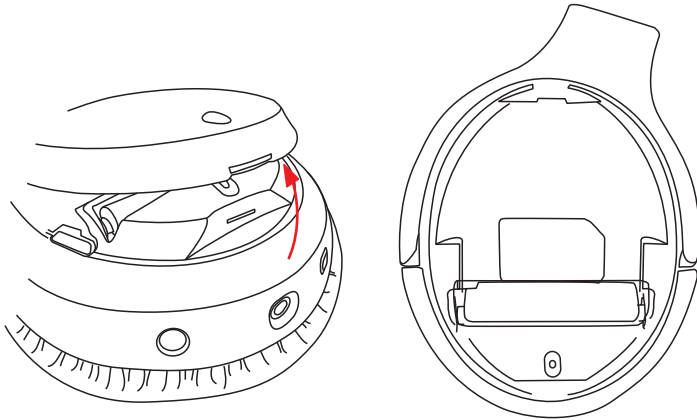

You can also use compatible batteries with the following specifications: 3.7V lithium ion 10440 rechargeable battery, capacity 350mAh.

Please visit [avantree.com/eon/replace-battery](https://avantree.com/eon/replace-battery) for installation instructions and recommended sellers' details.





## Specifications

EN

Bluetooth version	5.0
Audio codec support	AAC, SBC
Supported profiles	HSP v1.2, HFP v1.7, AVRCP v1.6 and A2DP v1.3.1
Operating range	Up to 50ft / 15m
Drivers	40mm
Impedance	32Ω
Frequency response	20Hz - 20KHz
Charging time	~2.5hrs
Operating time	Up to 45hrs (ANC off)
Standby time	325hrs (ANC off)
Sound pressure level (SPL)	100dB (1kHz / 179MV)
Total harmonic distortion (THD)	<0.5% (1kHz)
Product size	191mm x 156mm x 92mm
Headphones weight	~300g
Earpads inner diameter / depth	68mm x 47mm / 35mm
Earpads outer diameter	110mm x 90mm
Rated Input	DC5V/500mA~2.0A
Power port	Type C

## FAQ

Below are some of the most common questions people have during setup.

### **Why is the microphone not working with my PC?**

There are several reasons why the microphone may not be working with your PC. First and foremost, check the boom mic to ensure the mute switch is OFF (unmuted). The issue could also be related to hardware or computer settings. To determine if it's a hardware issue, connect the headphones to your phone and test call someone, trying both with and without the boom mic. If there are no issues, double check your computer settings.

- Make sure only one meeting app is open at a time.
- Ensure your PC settings are properly set - check your computer's sound settings and make sure the Eon is selected as both the output and input source. Check your meeting software's sound settings as well.
- Make sure there's no interference from a second device - if your Eon is simultaneously connected to another device via dual link, try disconnecting from the other device.

### **Why isn't my audio switching between my phone and PC with the dual link feature?**

To switch between your phone and your PC, first pause the audio / end the call on the current device (either by using the controls on your active device or by pressing the corresponding button on the headphones).

After 7-10 seconds, initiate audio on the second device. The Eon should automatically swap sources.

You can find a full FAQ list at [avantree.com/support/eon](https://avantree.com/support/eon), or contact us directly for additional assistance.

## Contact Us



**Support Tickets**

[avantree.com/submit-a-ticket](https://avantree.com/submit-a-ticket)



**Support Email**

[support@avantree.com](mailto:support@avantree.com)



**USA / CA**

+1800 232 2078 (9am-6pm PST, Mon-Fri)

**UK**

+44 20 8068 2023 (9am-6pm, GMT, Mon-Sat)

**DE**

+49 32221097297 (11am-9pm, CET, Mon-Sat)

**FR**

+ 33 176340312 (11am-9pm, CET, Mon-Sat)

**IT**

+39 06 9480 3330 (9am-6pm, CET, Mon-Sat)

**ES**

+ 34 931786261 (9am-6pm, CET, Mon-Sat)

**AU**

+ 61 2 8310 9897 (11am-7pm, AEST, Mon-Fri)



**FAQ**

[avantree.com/support/eon](https://avantree.com/support/eon)



**Product Registration**

[avantree.com/product-registration](https://avantree.com/product-registration)

# Inhaltsverzeichnis

DE

Inhalt der Box .....	19
Produkteinführung .....	20
Produktübersicht .....	20
Tasten Funktionen .....	21
LED Anzeigen .....	22
Aufladen der Kopfhörer .....	23
Anschließen des Kopfhörers an Ihr Gerät .....	24
Koppeln und Verbinden .....	24
Konfigurieren der Audioeinstellungen (nur für PC) .....	26
Mit dem Boom Mic telefonieren .....	28
Als kabelgebundene Kopfhörer verwenden .....	29
Auswechseln der wiederaufladbaren Batterie .....	30
Technische Daten .....	31
HÄUFIG GESTELLTE FRAGEN (FAQ) .....	32
Kontaktieren Sie uns .....	33

# Inhalt der Box

DE

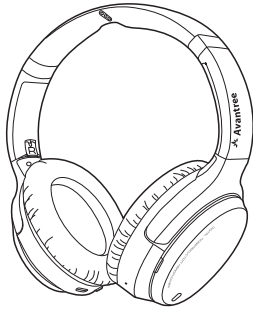

EON Kopfhörer

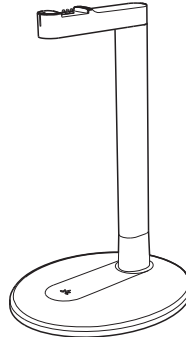

Ladeständer

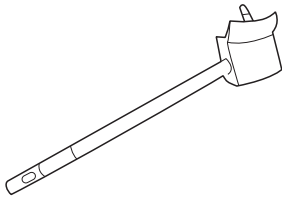

Mikrofon

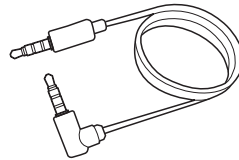

Aux 3,5 mm Audiokabel

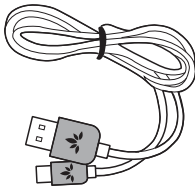

Typ C Netzkabel

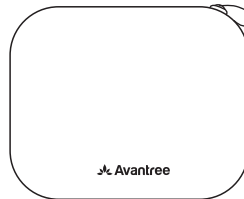

Tragetasche

# Produkteinführung

## Produktübersicht

DE

3 Taste für ANC / Transperanz/Normalmodus

B Hörmodus-Anzeige

4 Taste für den EQ-Modus

AUX 3.5mm jack

C Busylight



1 AN / AUS Verkabelt/ Kopplung

A Status Anzeige





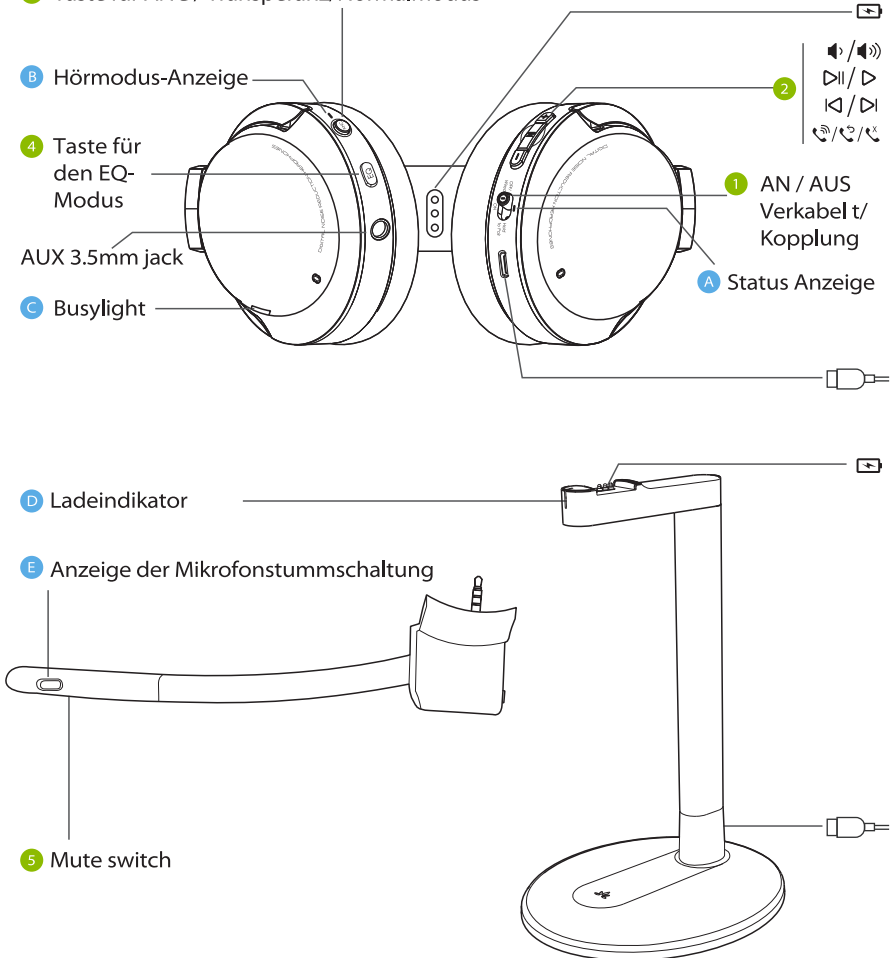

D Ladeindikator



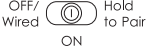

E Anzeige der Mikrofonstummschaltung

5 Mute switch



## Tasten Funktionen

Nr.	Taste	Funktionen
1		Stellen Sie den Schalter auf die Position "ON / OFF", um die Kopfhörer ein- oder auszuschalten
		Stellen Sie den Schalter auf die Position "WIRED", um die Kopfhörer als verkabelte Kopfhörer zu verwenden.
		Stellen Sie den Schalter auf die Position "HOLD TO PAIR" und halten Sie ihn 2 Sekunden lang gedrückt, um in den Pairing-Modus zu gelangen.
2		Einmal drücken, um die Wiedergabe zu starten / zu pausieren.
		Einmal drücken, um den Anruf anzunehmen / zu beenden.
		2 Sekunden lang gedrückt halten, um den Anruf abzulehnen.
		Zweimal drücken, um die letzte Nummer erneut zu wählen
		Einmal drücken, um die Lautstärke zu erhöhen / zu verringern.
		2 Sekunden lang gedrückt halten, um den nächsten / vorherigen Titel zu überspringen / wiederzugeben.
Beide Tasten 5 Sekunden lang gedrückt halten, um die Pairing-Historie zu löschen.		
	Beide Tasten "  &  " für 1 Sekunde gedrückt halten, um das Sidetone (Mikrofonüberwachung; hören Sie sich selbst sprechen) ein- oder auszuschalten.	

3		Einmal drücken, um zwischen den Modi "Aktive Geräuschunterdrückung", "Transparenz" (Umgebungsgeräusche hören) und "Normal" zu wechseln.
4		Einmal drücken, um zwischen den Modi "Ausgeglichene Klangwiedergabe" und "Bass-Boost" zu wechseln.
5	 (on boom mic)	Schalten Sie  /  auf "Stummschalten / Mikrofon aktivieren"

## LED Indicators

Nr.	Anzeige & Sprachansage	Status
	Durchgehend rot leuchtend	Aufladung
	Rot blinkend	Schwache Batterie
	Blau blinkend Sprachausgabe "BATTERY HIGH / MEDIUM / LOW"	Einschalten
	Durchgehend rot leuchtend für 1 Sekunde und dann aus	Ausgeschaltet
A	Blinkt abwechselnd rot und blau, Sprachanzeige "PAIRING".	Kopplung
	Blaues Blinken alle 5 Sekunden, Sprachanzeige "CONNECTED".	Verbunden
	Blaues Blinken alle 2 Sekunden, Sprachanzeige "DISCONNECTED"	Getrennt
	5 Sekunden durchgehend rosa, dann abwechselnd rotes und blaues Blinken	Kopplungsverlauf löschen



Nr.	Anzeige & Sprachansage	Status
B	Durchgehend grün leuchtend , begleitet von der Sprachausgabe "NOISE CANCELING"	Aktive Geräuschunterdrückung (ANC)
	Grünes Blinken alle 5 Sekunden begleitet von der Sprachausgabe "TRANSPARENCY"	Transparenz-Modus
	LED aus, begleitet von der Sprachausgabe "NORMAL"	Normaler Modus
C	Durchgehend rot leuchtend	In einem Anruf
D	Durchgehend rot Weiss	Aufladen
	Durchgehend rot Grün	Ladevorgang abgeschlossen
E	Durchgehend rot leuchtend	Stummgeschaltetes Mikrofon

## Aufladen der Kopfhörer

Eine Sprachansage "BATTERY LOW" und ein rotes Blinken zeigen einen niedrigen Akkustand an. Zum Aufladen können Sie entweder einen 5V/500mA-2A USB-Adapter (Ihr Handy-Ladegerät oder ähnliches sollte funktionieren) oder einen PC-USB-Anschluss als Stromquelle verwenden.

### OPTION 1 Aufladen mit dem Ladeständer:

Legen Sie die Kopfhörer auf den Ladeständer. Die LED des Ladeständers leuchtet während des Ladens weiß und wird grün, sobald der Ladevorgang abgeschlossen ist.

## OPTION 2 Aufladen über das USB-Kabel:

DE

Alternativ können Sie das mitgelieferte Typ-C-Netzkabel direkt in den Ladeanschluss der Kopfhörer einstecken.

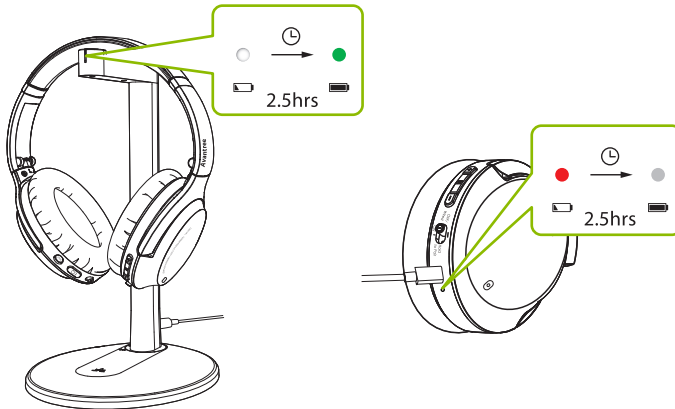

Eine durchgehend rote Leuchte zeigt an, dass der Ladevorgang im Gange ist. Sobald das Licht erlischt, sind die Kopfhörer vollständig aufgeladen und der Ladevorgang ist abgeschlossen.

# Anschließen des Kopfhörers an Ihr Gerät

## Koppeln und Verbinden

### SCHRITT 1

Schalten Sie die Kopfhörer ein. Bei der ersten Verwendung tritt der Kopfhörer automatisch in den PAIRING-Modus.

Falls dies nicht der Fall ist, setzen Sie die Kopfhörer in den PAIRING-Modus, indem Sie den Schalter  auf "HOLD TO PAIR" schieben und ihn

2 Sekunden lang gedrückt halten, bis die LED rot und blau blinkt.

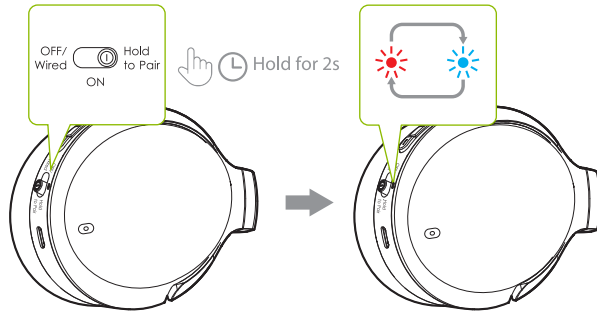

### SCHRITT 2

Schalten Sie Bluetooth auf Ihrem Gerät ein und wählen Sie "Avantree Eon" im Bluetooth-Menü aus.

### SCHRITT 3

Halten Sie die Kopfhörer in der Nähe Ihres Geräts und warten Sie 5-10 Sekunden oder bis sie verbunden sind. Sobald sie erfolgreich verbunden sind, blinkt die LED-Anzeige der Kopfhörer blau und Sie hören eine Sprachansage "CONNECTED".

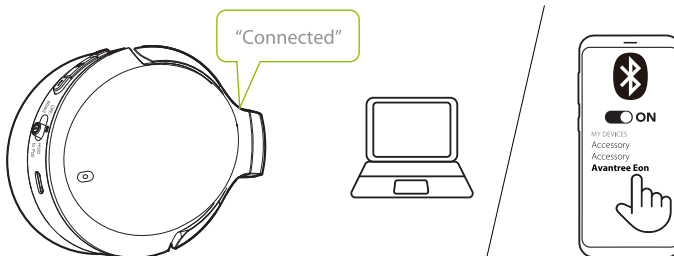

Wenn Sie den Kopfhörer später wieder benutzen, sollte er sich automatisch mit dem innerhalb weniger Sekunden nach dem Einschalten wieder mit dem zuletzt gepaarten Gerät verbinden.

Falls dies nicht der Fall ist, können Sie die erneute Verbindung manuell aktivieren, indem Sie den Schalter  einmal auf "HOLD TO PAIR" setzen oder "Avantree Eon" im Bluetooth-Menü Ihres Geräts auswählen.

## Konfigurieren der Audioeinstellungen (nur für PC)

DE

Möglicherweise müssen Sie Ihre Audioeinstellungen konfigurieren, wenn Sie den Eon mit Ihrem PC oder Laptop verwenden.

### SCHRITT 1

Öffnen Sie die Audio-Einstellungen Ihres Geräts und stellen Sie "Avantree Eon" als Standard in SOUNDAUSGABE / WIEDERGABE ein. Wählen Sie "Avantree Eon" als Standardgerät in EINGABE / MIKROFON aus.

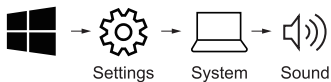

### Sound

**Output**  
Choose your output device

Avantree Eon ▾

**Input**  
Choose your input device

Avantree Eon ▾

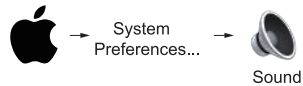

### Sound

**Output**  
Select a device for sound output:

Avantree Eon

**Input**  
Select a device for sound input:

Avantree Eon

**SCHRITT 2:**

Wiederholen Sie die oben genannten Schritte in Ihrer Meetingsoftware (z.B. Teams, Zoom, Skype, etc.)

DE

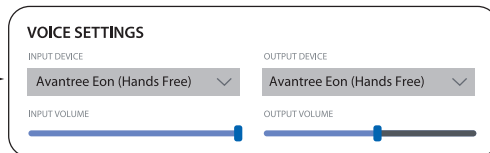
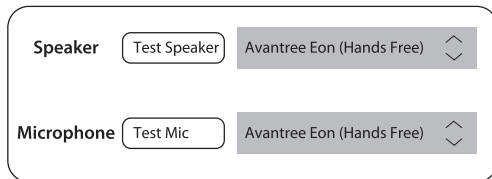
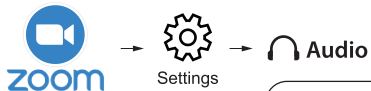
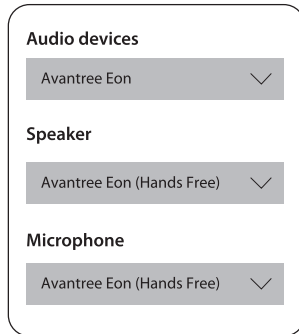
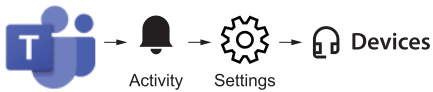

*HINWEIS: Unter Windows 11/macOS gibt es keine Option "Freisprecheinrichtung". Wählen Sie stattdessen "Avantree Eon" als Standard aus.*

## Mit dem Boom Mic telefonieren

DE

Die Eon Kopfhörer selbst verfügen über ein integriertes Mikrofon, aber die Verwendung des abnehmbaren Boom-Mikrofons wird die Anrufqualität erheblich verbessern. Die Rauschfiltertechnologie sorgt dafür, dass Ihre Stimme (und nur Ihre Stimme) laut und klar gehört wird, und der Stummschalter kann bequem genutzt werden.

Wir empfehlen dringend, das Boom-Mikrofon für Ihre Anrufe zu verwenden. Sie können es sowohl im drahtlosen als auch im kabelgebundenen Modus verwenden, indem Sie es in die Kopfhörer einstecken und optional das AUX-Kabel direkt mit dem Boom-Mikrofon verbinden.

# Als kabelgebundene Kopfhörer verwenden

## SCHRITT 1

Schieben Sie den Schalter

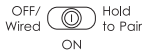

auf "OFF / Wired"

DE

## SCHRITT 2

### OPTION 1

Wenn Sie das Mikrofon nicht benötigen, stecken Sie das AUX-3,5-mm-Audiokabel in die Kopfhörer und Ihr Audioausgabegerät.

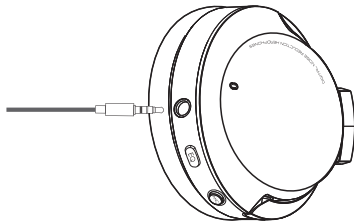

### OPTION 2

Wenn Sie Anrufe tätigen möchten, schließen Sie zuerst das abnehmbare Boom-Mikrofon an den Kopfhörer an und stecken dann das AUX-3,5-mm-Audiokabel in das Mikrofon. Stecken Sie das andere Ende des Kabels in Ihr Audio-Ausgabegerät.

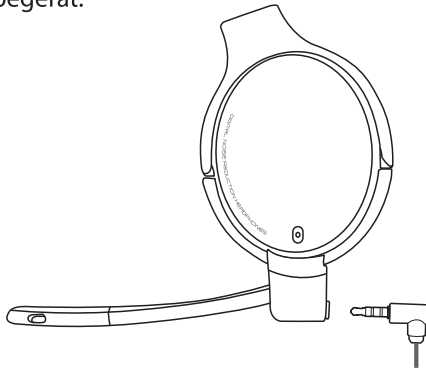

*HINWEIS: Im Kabelbetrieb funktionieren die Hörmodi (ANC, Transparenz, normal) und alle anderen integrierten Tasten nicht. Der Schalter am abnehmbaren Boom-Mikrofon funktioniert jedoch weiterhin.*

## Auswechseln der wiederaufladbaren Batterie

DE

Die wiederaufladbaren Batterien, die sich in beiden Ohrmuscheln der Kopfhörer befinden, können ausgetauscht werden, um die Lebensdauer Ihrer Eon-Kopfhörer zu verlängern. Scannen Sie den unten stehenden QR-Code oder suchen Sie nach "Avantree Eon-Batterie" auf Amazon oder der Avantree-Website, um einen Kauf zu tätigen.

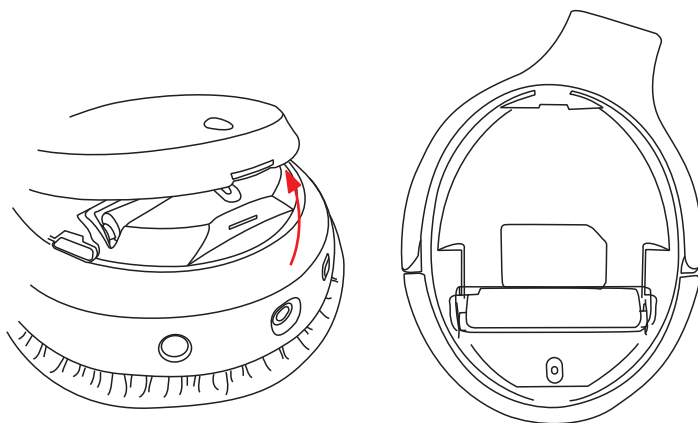

Sie können auch kompatible Batterien mit den folgenden Spezifikationen verwenden: 3,7V Lithium-Ionen-10440 wiederaufladbare Batterie, Kapazität 350mAh.

Besuchen Sie [avantree.com/eon/replace-battery](https://avantree.com/eon/replace-battery) für Installationsanweisungen und Details zu empfohlenen Verkäufern.





## Technische Daten

Bluetooth-Version	5.0
Unterstützte Audio-Codexs	AAC, SBC
Unterstützte Profile	HSP v1.2, HFP v1.7, AVRCP v1.6 and A2DP v1.3.1
Betriebsreichweite	Up to 50ft / 15m
Treiber	40mm
Impedanz	32Ω
Frequenzbereich	20Hz - 20KHz
Ladezeit	~2.5hrs
Betriebszeit	Up to 45hrs (ANC off)
Standby-Zeit	325hrs (ANC off)
Schalldruckpegel (SPL)	100dB (1kHz / 179MV)
Gesamtklirrfaktor (THD)	<0.5% (1khz)
Produktgröße	191mm x 156mm x 92mm
Gewicht der Kopfhörer	~300g
Innendurchmesser / -tiefe der Ohrpolster	68mm x 47mm / 35mm
Außendurchmesser der Ohrpolster	110mm x 90mm
Stromversorgung	DC5V/500mA~2.0A
Stromanschluss	Type C

## HÄUFIG GESTELLTE FRAGEN (FAQ)

DE

Nachfolgend finden Sie einige der am häufigsten gestellten Fragen während der Einrichtung.

### **Warum funktioniert das Mikrofon nicht mit meinem PC?**

Es gibt mehrere Gründe, warum das Mikrofon möglicherweise nicht mit Ihrem PC funktioniert. Überprüfen Sie zunächst das Boom-Mikrofon, um sicherzustellen, dass der Stummschalter AUS (nicht stummgeschaltet) ist. Das Problem könnte auch mit der Hardware oder den Computer-Einstellungen zusammenhängen. Um festzustellen, ob es sich um ein Hardware-Problem handelt, schließen Sie die Kopfhörer an Ihr Telefon an und testen Sie einen Anruf, indem Sie sowohl mit als auch ohne das Boom-Mikrofon ausprobieren. Wenn es keine Probleme gibt, überprüfen Sie Ihre Computer-Einstellungen.

Stellen Sie sicher, dass nur eine Meeting-App gleichzeitig geöffnet ist. Stellen Sie sicher, dass Ihre PC-Einstellungen ordnungsgemäß eingestellt sind - überprüfen Sie die Sound-Einstellungen Ihres Computers und stellen Sie sicher, dass das Eon als Ausgabe- und Eingangsquelle ausgewählt ist. Überprüfen Sie auch die Sound-Einstellungen Ihrer Meeting-Software. Stellen Sie sicher, dass keine Störungen von einem zweiten Gerät ausgehen - wenn Ihr Eon gleichzeitig über eine Dual-Link-Verbindung mit einem anderen Gerät verbunden ist, versuchen Sie, sich von dem anderen Gerät zu trennen.

### **Warum schaltet mein Audiosignal mit der Dual Link-Funktion nicht zwischen Telefon und PC um?**

Um zwischen Ihrem Telefon und Ihrem PC zu wechseln, unterbrechen Sie zuerst die Audio-Wiedergabe / beenden Sie den Anruf auf dem aktuellen Gerät (entweder mit den Steuerungen auf Ihrem aktiven Gerät oder indem Sie die entsprechende Taste auf den Kopfhörern drücken). Warten Sie 7-10 Sekunden und starten Sie die Audio-Wiedergabe auf dem zweiten Gerät. Der Eon sollte automatisch die Quellen wechseln.

Sie finden eine vollständige Liste häufig gestellter Fragen auf [avantree.com/support/eon](https://avantree.com/support/eon) oder kontaktieren Sie uns direkt für zusätzliche Unterstützung.

## Kontaktieren Sie uns



**Ticket-Support**

[avantree.com/submit-a-ticket](https://avantree.com/submit-a-ticket)



**Support-E-Mail**

[support@avantree.com](mailto:support@avantree.com)



**USA / CA**

+1800 232 2078 (9am-6pm PST, Mon-Fri)

**UK**

+44 20 8068 2023 (9am-6pm, GMT, Mon-Sat)

**DE**

+49 32221097297 (11am-9pm, CET, Mon-Sat)

**FR**

+ 33 176340312 (11am-9pm, CET, Mon-Sat)

**IT**

+39 06 9480 3330 (9am-6pm, CET, Mon-Sat)

**ES**

+ 34 931786261 (9am-6pm, CET, Mon-Sat)

**AU**

+ 61 2 8310 9897 (11am-7pm, AEST, Mon-Fri)



**FAQ**

[avantree.com/support/eon](https://avantree.com/support/eon)



**Produktregistrierung**

[avantree.com/product-registration](https://avantree.com/product-registration)

# Sommaire

Contenu de la boîte .....	35
Introduction .....	36
Vue d'ensemble produit .....	36
Fonctions des boutons .....	37
Indicateurs LED .....	38
Recharge du casque .....	39
Connexion du casque à votre équipement.....	40
Appairage & Connexion .....	40
Réglage des paramètres audio (PC) .....	42
Appels avec micro-perche.....	44
Usage du casque en filaire .....	45
Remplacer la batterie .....	46
Spécifications .....	47
FAQ .....	48
Comment nous contacter .....	49

# Contenu de la boîte

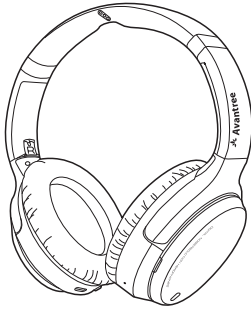

Casque audio Eon

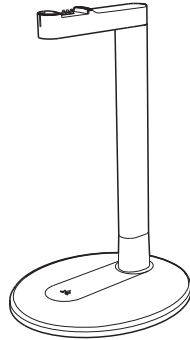

Support de rangement  
et de charge

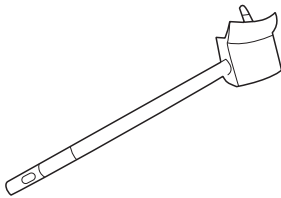

Micro-perche

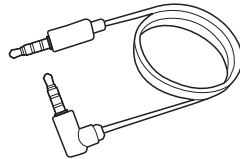

Câble audio AUX 3.5mm

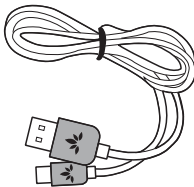

Câble d'alimentation  
de Type C

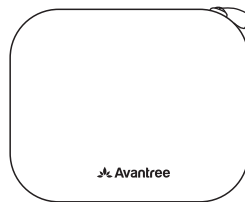

Sacoche de transport







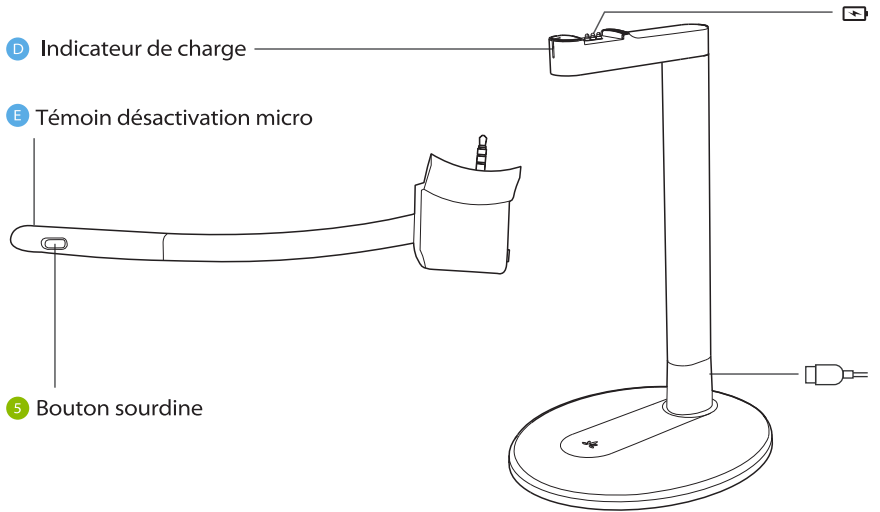
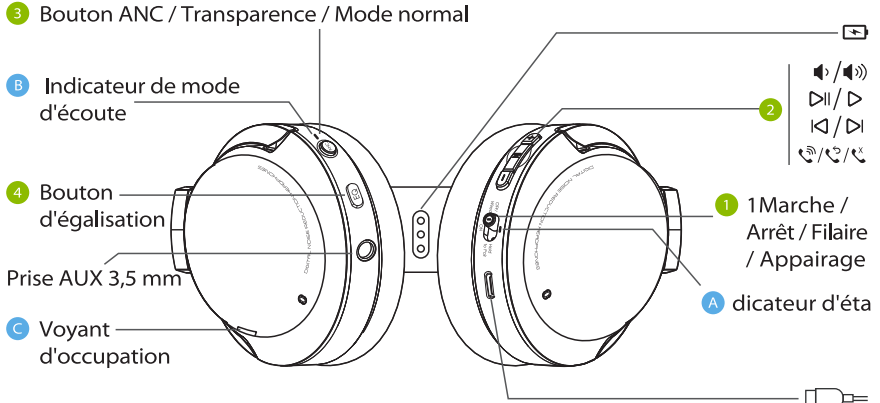



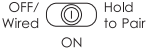

# Introduction

## Vue d'ensemble produit

FR



## Button Functions

No.	Bouton	Fonctions
1		Positionner sur "ON / OFF" pour allumer ou éteindre le casque
		Positionner sur "WIRED" pour un usage filaire du casque
		Positionner 2 secondes sur "HOLD TO PAIR" pour passer le casque en appairage
2		Appuyer 1 fois pour lecture / pause
		Appuyer 1x pour prendre / terminer un appel
		Appuyer et maintenir 2s pour rejeter un appel
		Appuyer 2x pour recomposer un appel
		Appuyer 1x pour augmenter / baisser le volume
		Appuyer et maintenir 2s pour passer / rejouer une piste
	Appuyer et maintenir 5s pour effacer l'historique d'appairage	
	Appuyer et maintenir ensemble "  " et "  " durant 1s pour activer / désactiver la fonction sidetone (capter et entendre votre voix dans le micro)	
3		Appuyez 1x pour basculer entre les modes Annulation active du bruit / Transparence (environnement audible) / Normal.
4		Appuyez 1x pour basculer entre les modes équilibré et basses accentuées
5	 (on boom mic)	Positionner  /  pour désactiver / activer le micro

## LED Indicators

FR

Nb.	Indicateurs & Vocalises	Statut
A	Rouge fixe	En charge
	Rouge clignotant	Batterie faible
	Bleu clignotant, vocalise "BATTERY HIGH / MEDIUM / LOW"	Mise en marche
	Rouge fixe (1s) puis extinction, vocalise "GOODBYE"	Arrêt
	Rouge & bleu alterné, vocalise "PAIRING"	Appairage
	Bleu clignotant toutes les 5s, vocalise "CONNECTED"	Connecté
	Bleu clignotant toutes les 2s, vocalise "DISCONNECTED"	Déconnecté
	Rose durant 5s, puis rouge & bleu alterné	Historique d'appairage effacé
B	Vert fixe, vocalise "NOISE CANCELING"	Mode ANC actif (réduction de bruit environnant)
	Vert clignotant toutes les 5s, vocalise "TRANSPARENCY"	Mode transparence (bruit environnant augmenté)
	LED éteinte, vocalise "NORMAL"	Mode normal
C	Rouge fixe	En appel
D	Blanc fixe	En charge
	Vert fixe	Charge terminée
E	Rouge fixe	Micro désactivé



## Recharge du casque

Une vocalise "BATTERY LOW" et une LED clignotante **A** indique une batterie faible. Pour la recharge et comme source d'alimentation, vous pouvez utiliser soit un adaptateur USB 5V/500mA-2A (ex. chargeur de téléphone ou similaire) ou un port USB PC.

### OPTION 1 Recharge via le support du casque

Placez les écouteurs sur le support de charge. La LED de la station de charge deviendra blanche pendant la charge et verte une fois la charge terminée.

### OPTION 2 Via un câble USB

Alternativement, vous pouvez brancher directement le câble USB fourni de type C dans le port de charge du casque.

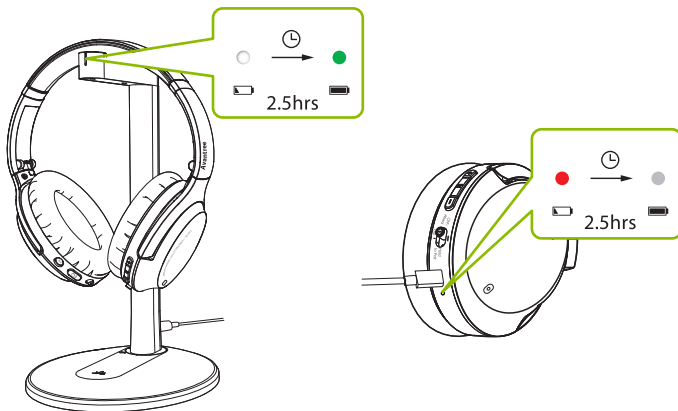

Un voyant rouge fixe indique que la charge est en cours. Une fois la lumière éteinte, vos écouteurs seront rechargés.

# Connexion du casque à votre appareil

## Appairage & Connexion

FR

### ETAPE 1

Allumez les écouteurs. Lors de la première utilisation, le casque entrera automatiquement en APPAIRAGE.

Sinon, maintenez 2s le bouton  sur "HOLD TO PAIR" jusqu'à ce que la LED clignote en rouge et bleu.

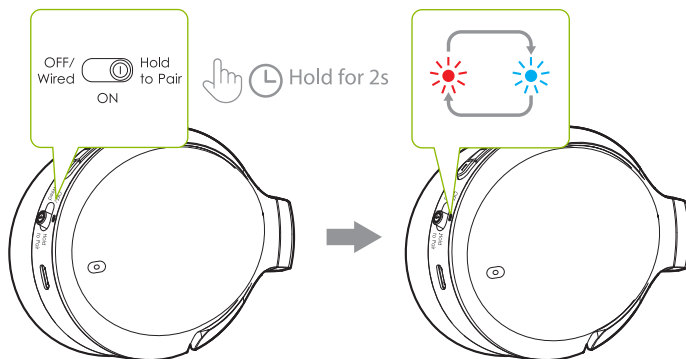



### ETAPE 2

Activez le Bluetooth de votre appareil et sélectionnez "Avantree Eon" dans le menu Bluetooth.

### ETAPE 3

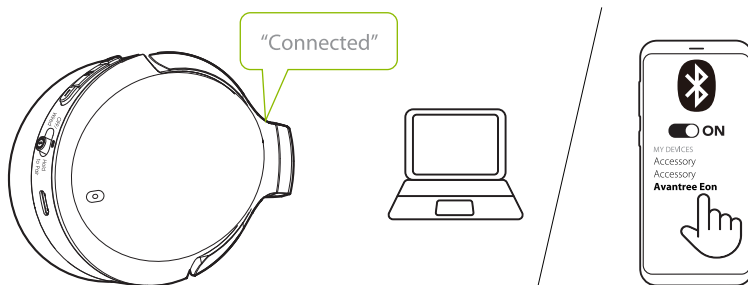
Gardez les écouteurs près de votre appareil et attendez 5 à 10 secondes ou jusqu'à ce qu'ils se connectent. Une fois connectés avec succès, le voyant LED du casque clignote en bleu et vous entendrez un indicateur vocal "CONNECTED".



Pour une utilisation ultérieure, votre casque devrait se reconnecter automatiquement au appareil couplé après quelques secondes et sa mise sous tension. Si non, vous pouvez lancer manuellement la reconnexion en faisant glisser le bouton  sur "HOLD TO PAIR" une fois, ou en sélectionnant "Avantree Eon" dans le menu Bluetooth de votre appareil.

## Configuration des paramètres audio (sur PC)

Vous devrez peut-être configurer vos paramètres audio lorsque vous utilisez l'Eon avec votre PC ou votre ordinateur portable.

FR

### ETAPE 1

Accédez aux paramètres audio et définissez "Avantree Eon" par défaut dans SORTIE SON / LECTURE (ou similaire). Réglez "Avantree Eon" comme valeur par défaut dans ENTREE / MICRO (ou similaire).

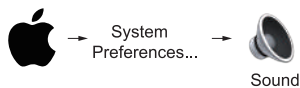
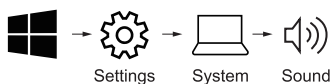

**Sound**

**Output**  
Choose your output device

Avantree Eon ▾

**Input**  
Choose your input device

Avantree Eon ▾

**Sound**

**Output**  
Select a device for sound output:

Avantree Eon

**Input**  
Select a device for sound input:

Avantree Eon

**ETAPE 2:**

Répétez les étapes ci-dessus dans votre logiciel de réunion (ex. Teams, Zoom, Skype, etc.)

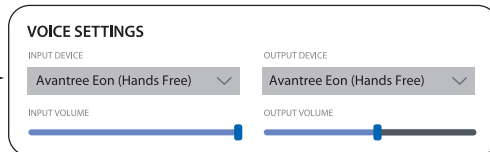
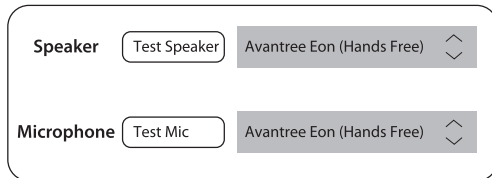
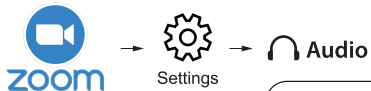
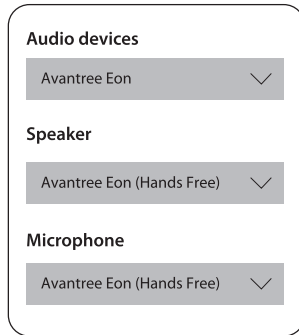
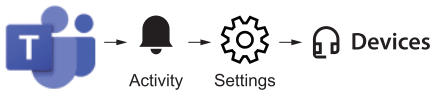

*NOTE: Sur Windows 11/ macOS, l'option "Hands Free" est absente. Sélectionnez "Avantree Eon" par défaut.*

## Appels avec micro-perche

Les écouteurs Eon disposent d'un micro intégré. Mais l'utilisation du micro-perche amovible améliorera considérablement la qualité de vos appels. Sa technologie de filtrage du bruit garantira que votre voix (et uniquement votre voix) est entendue haut et clair. De plus, son bouton de sourdine peut être facilement utilisé.

Nous vous recommandons fortement d'utiliser le micro perche pour vos appels. Vous pouvez l'utiliser en mode sans fil et filaire, en le branchant sur le casque et (éventuellement) en connectant le câble AUX directement au micro-perche.

# Utiliser le casque en filaire

## ETAPE 1

Glissez le bouton  sur "OFF / Wired." Hold to Pair

## ETAPE 2

### OPTION 1

Si vous n'avez pas besoin du micro, branchez le câble audio AUX 3,5 mm dans les écouteurs et votre périphérique de sortie audio.

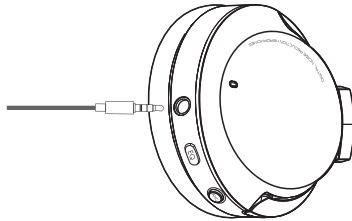

### OPTION 2

Si vous souhaitez passer des appels, branchez d'abord le micro-perche dans le casque, puis branchez le câble audio AUX 3,5 mm dans le micro. Branchez l'autre extrémité du câble dans votre périphérique de sortie audio.

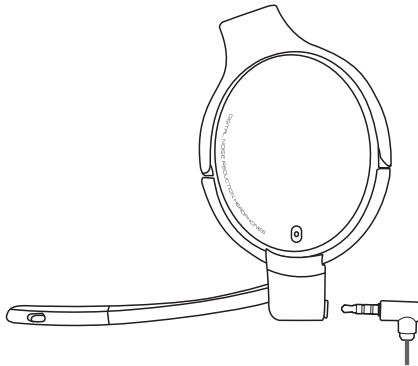

*NOTE: En connexion filaire, les modes ANC, transparence, normal et autres boutons intégrés ne fonctionnent pas. En revanche, le bouton du micro-perche fonctionnera.*

## Remplacer la batterie

FR

L'EON dispose de batteries rechargeables situées dans les deux écouteurs. Elles peuvent être remplacées pour prolonger la durée de vie de votre casque audio. Pour en acheter, scannez le code QR ci-dessous ou recherchez "Batterie Avantree Eon" sur Amazon (ou sur notre site web [www.avantree.com](http://www.avantree.com)).

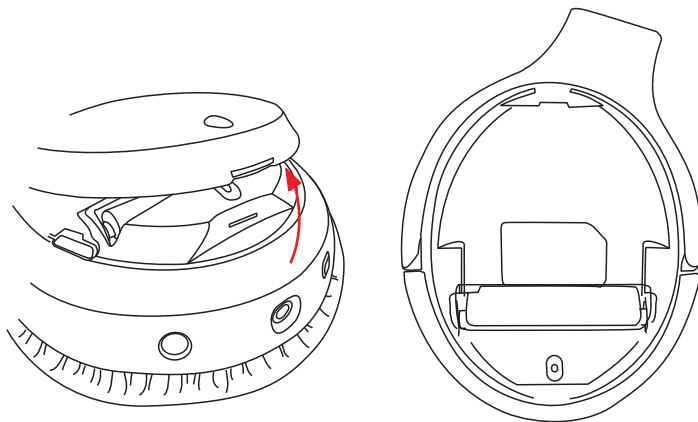

Vous pouvez également utiliser des batteries compatibles avec les spécifications suivantes : batterie rechargeable 3,7 V lithium-ion 10440, capacité 350 mAh.

Visitez notre site [avantree.com/eon/replace-battery](http://avantree.com/eon/replace-battery) pour des instructions d'installation et plus de détails sur les vendeurs recommandés.





## Spécifications

Version Bluetooth	5.0
Codecs audio supportés	AAC, SBC
Profils supportés	HSP v1.2, HFP v1.7, AVRCP v1.6 and A2DP v1.3.1
Portée de fonctionnement	Jusqu'à 15m
Diamètre haut-parleurs	40mm
Impédance	32Ω
Réponse en fréquence	20Hz - 20KHz
Temps de recharge	~2h30
Autonomie	Jusqu'à 45h (ANC éteint)
Veille	325h (ANC éteinte)
Pression acoustique (SPL)	100dB (1kHz / 179MV)
Distorsion harmonique totale (THD)	<0.5% (1khz)
Dimensions produit	191mm x 156mm x 92mm
Poids du casque	~300g
Diamètre intérieur / profondeur des coussinets	68mm x 47mm / 35mm
Diamètre extérieur des coussinets	110mm x 90mm
Alimentation de charge	DC5V/500mA~2.0A
Prise de charge	Type C

## FAQ

Vous trouverez ci-dessous certaines des questions les plus fréquemment posées par les utilisateurs lors de la configuration.

FR

### **Pourquoi le micro ne fonctionne-t-il pas avec mon PC?**

Il existe plusieurs raisons. Tout d'abord, vérifiez le micro-perche pour vous assurer que l'interrupteur sourdine est sur OFF (micro actif). Le problème peut également être lié au matériel ou aux paramètres de l'ordinateur. Pour déterminer s'il s'agit d'un problème matériel, connectez le casque à votre téléphone et essayez de passer un appel, avec et sans le micro-perche. S'il n'y a aucun problème, vérifiez les paramètres de votre ordinateur :

- Vérifiez que des applications d'appel ne fonctionnent pas en double.
- Vérifiez que les paramètres son de votre PC sont correctement définis et assurez-vous que l'Eon est bien sélectionné, à la fois comme source de sortie et d'entrée. Vérifiez également les paramètres sonores de votre logiciel d'appel/conférence.
- Vérifiez qu'il n'y a pas d'interférence provenant d'un deuxième appareil. Si votre Eon est simultanément connecté à un autre appareil via une double liaison, essayez de vous déconnecter de l'autre appareil.

### **Pourquoi mon audio ne bascule-t-il pas entre mon téléphone et mon PC avec la fonction de double liaison?**

Pour basculer entre votre téléphone et votre PC, mettez d'abord en pause l'audio ou mettez fin à votre appel sur l'appareil en cours (soit en utilisant les commandes de votre appareil actif, soit en appuyant sur le bouton correspondant sur le casque).

Après 7 à 10 secondes, lancez l'audio sur le deuxième appareil. L'Eon devrait changer de source automatiquement.

Une liste complète des FAQ est consultable en suivant ce lien [avantree.com/support/eon](https://avantree.com/support/eon). Pour une assistance supplémentaire, contactez-nous directement via les liens ci-dessous.

## Comment nous contacter



**Support en ligne**

[avantree.com/submit-a-ticket](https://avantree.com/submit-a-ticket)



**Support via email**

[support@avantree.com](mailto:support@avantree.com)



**USA / CA**

+1800 232 2078 (9am-6pm PST, Mon-Fri)

**UK**

+44 20 8068 2023 (9am-6pm, GMT, Mon-Sat)

**DE**

+49 32221097297 (11am-9pm, CET, Mon-Sat)

**FR**

+ 33 176340312 (11am-9pm, CET, Mon-Sat)

**IT**

+39 06 9480 3330 (9am-6pm, CET, Mon-Sat)

**ES**

+ 34 931786261 (9am-6pm, CET, Mon-Sat)

**AU**

+ 61 2 8310 9897 (11am-7pm, AEST, Mon-Fri)



**FAQ**

[avantree.com/support/eon](https://avantree.com/support/eon)



**Enregistrement produit**

[avantree.com/product-registration](https://avantree.com/product-registration)

# Contenuti

Contenuto della Confezione .....	51
Introduzione al Prodotto .....	52
Panoramica del prodotto .....	52
Funzione dei Tasti .....	53
Indicatori LED .....	54
Ricaricare le Cuffie .....	55
Collegare le Cuffie ai Dispositivi .....	56
Pairing & Connessione .....	56
Configurazione Impostazioni Audio (solo per PC) .....	58
Chiamare con il Microfono .....	60
Utilizzo come Cuffie Cablate .....	61
Sostituire la Batteria Ricaricabile .....	62
Specifiche .....	63
FAQ .....	64
Contatti .....	65

## Contenuto della confezione

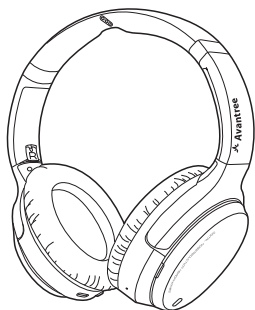

Cuffie Eon

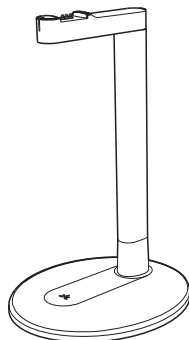

Supporto di ricarica

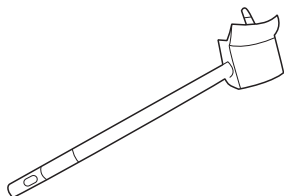

Microfono boom

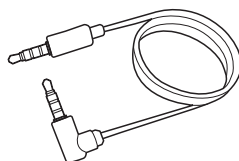

Cavo audio AUX da 3,5 mm

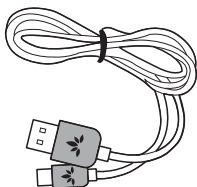

Cavo di alimentazione  
di tipo C

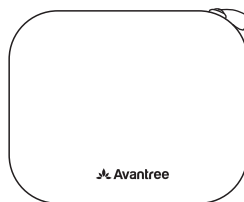

Custodia









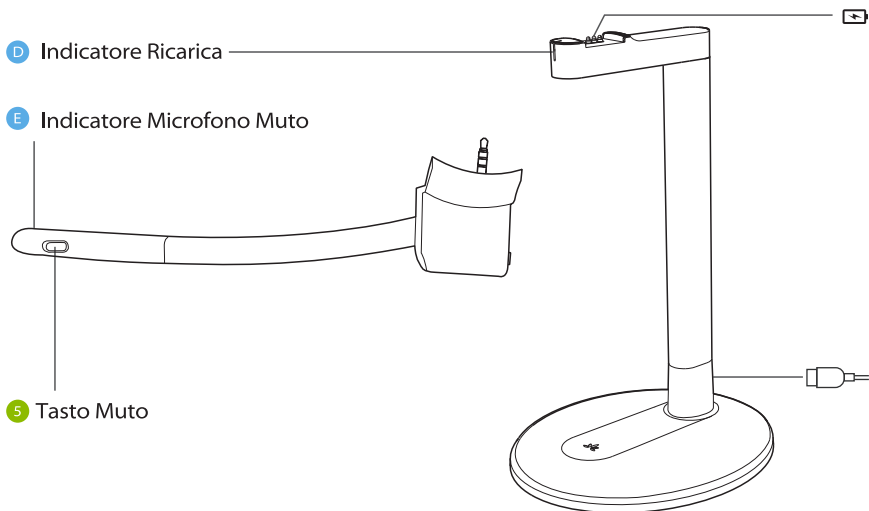
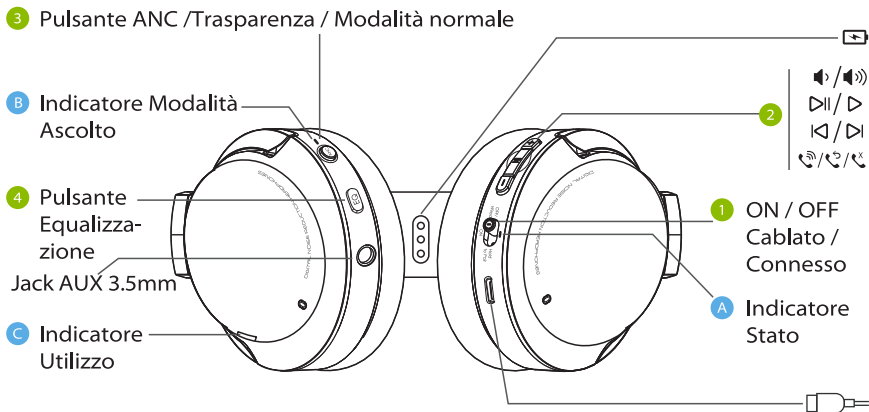

# Introduzione al Prodotto

## Panoramica del Prodotto

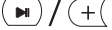
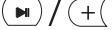
IT



## Funzione dei Tasti

No.	Tasto	Funzione
1		Passare alla posizione "ON/OFF" per accendere / spegnere le cuffie
		Passare alla posizione "WIRED" per utilizzare come cuffie cablate
		Passare alla posizione "HOLD TO PAIR" e tenere premuto per 2 secondi per accedere alla modalità di associazione
2		Premere una volta per riprodurre / mettere in pausa
		Premere una volta per accettare / terminare la chiamata
		Tenere premuto per 2 secondi per rifiutare la chiamata
		Premere due volte per ricomporre l'ultimo numero
		Premere una volta per aumentare / diminuire il volume
		Tenere premuto per 2 secondi per saltare / riprodurre la traccia
 / 	Tenere premuti entrambi i pulsanti per 5 secondi per cancellare la cronologia degli accoppiamenti	
3		Premi una volta per alternare le modalità Cancellazione attiva del rumore / Trasparenza (ascolta l'ambiente circostante) / Normale.
4		Premere una volta per passare dalla modalità bilanciata a quella con potenziamento dei bassi
5	 (on boom mic)	Cambiare tra  /  per silenziare / attivare il microfono

## Indicatori LED

No.	Indicatore e Messaggio Vocale	Stato
A	Rosso fisso	Carica
	Rosso lampeggiante	Batteria scarica
	Blu lampeggiante, indicatore vocale "BATTERIA ALTA / MEDIA / BASSA".	Accensione
	Rosso fisso per 1 secondo poi spento, indicatore vocale "GOODBYE".	Spegnimento
	Rosso e Blu che lampeggiano alternati, indicazione vocale "PAIRING".	Pairing
	Blu lampeggiante ogni 5 secondi, indicatore vocale "CONNESSO".	Connessione
	Blu lampeggiante ogni 2 secondi, indicatore vocale "DISCONNESSO".	Disconnessione
B	Rosa fisso per 5 secondi, quindi lampeggi rossi e blu alternati	Storico connessioni cancellato
	Verde fisso, indicatore vocale "NOISE CANCELING".	Modalità di Cancellazione Attiva del Rumore (ANC).
	Verde lampeggiante ogni 5 secondi, indicazione vocale "TRANSPARENCY".	Modalità Trasparenza
	LED spento, indicatore vocale "NORMALE".	Modalità normale
C	Rosso fisso	In chimata
D	Bianco fisso	Ricarica
	Verde fisso	Ricarica completata
E	Rosso fisso	Microfono Muto



## Ricarica

Un messaggio vocale "BATTERIA SCARICA" e una luce rossa lampeggiante **A** indicheranno che la batteria è scarica. Per caricare, è possibile utilizzare un adattatore USB da 5V/500 mA-2 A (il caricatore del telefono o simili dovrebbe funzionare) o la porta USB del PC come fonte di alimentazione.

### OPZIONE 1 Ricarica con il supporto

Posiziona le cuffie sul supporto di ricarica. Il LED del dock di ricarica diventerà bianco durante la ricarica e diventerà verde una volta completata la ricarica.

### OPZIONE 2 Ricarica con cavo USB

In alternativa, puoi collegare il cavo di alimentazione di tipo C in dotazione direttamente alla porta di ricarica delle cuffie.

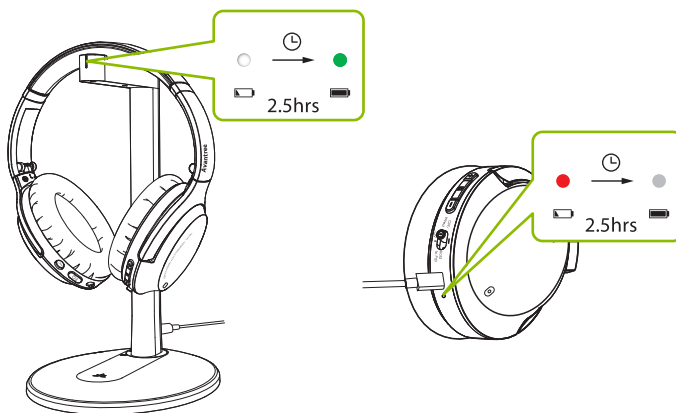

Una luce rossa fissa indica che la ricarica è in corso; una volta che la luce si spegne, le tue cuffie saranno completamente cariche.

# Collegamento delle Cuffie al Dispositivo

## Pairing & Connessione

### Passo 1

Accendi le cuffie. Al primo utilizzo, le cuffie entreranno automaticamente in modalità PAIRING.

In caso contrario, metti le cuffie in modalità PAIRING facendo scorrere il tasto

OFF/Wired  Hold to Pair ON nella posizione "HOLD TO PAIR" per 2 secondi fino a quando il

LED lampeggia in rosso e blu.

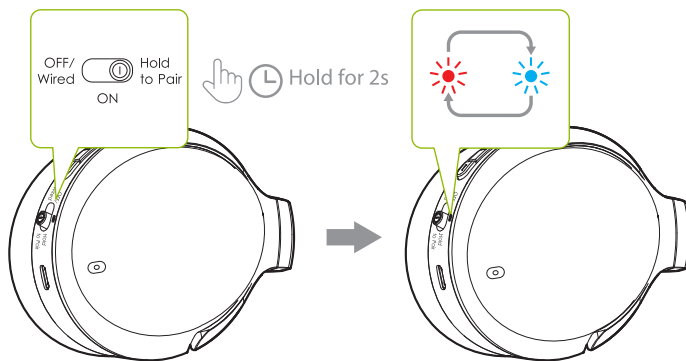



### Passo 2

Attiva il Bluetooth del tuo dispositivo e seleziona "Avantree Eon" nel menu Bluetooth.

### Passo 3

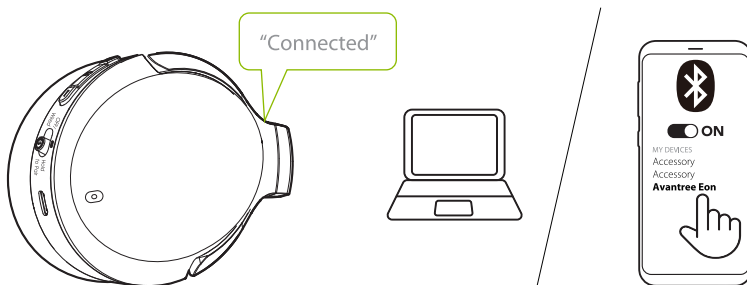
Tieni le cuffie vicino al tuo dispositivo e attendi 5-10 secondi o finché non si connettono. Una volta collegati correttamente, l'indicatore LED delle cuffie lampeggerà in blu e sentirai un indicatore vocale "CONNESSO".



Per un utilizzo successivo, le cuffie dovrebbero riconnettersi automaticamente all'ultimo dispositivo associato entro pochi secondi dall'accensione. In caso contrario, è possibile attivare manualmente la riconnessione facendo scorrere il tasto  sulla posizione "HOLD TO PAIR" una volta, o selezionando "Avantree Eon" nel menu Bluetooth del tuo dispositivo.

## Configurazione delle Impostazioni Audio (solo per PC)

Potrebbe essere necessario configurare le impostazioni audio quando si utilizza Eon con il PC o il laptop.

IT

### Passo1

Accedi alle impostazioni audio del tuo dispositivo e imposta "Avantree Eon" come predefinito in USCITA AUDIO / RIPRODUZIONE. Impostare "Avantree Eon" come predefinito in INPUT / MICROPHONE DEVICE.

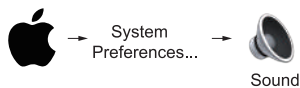
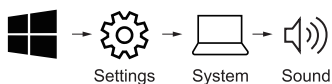

Sound

**Output**  
Choose your output device

Avantree Eon

**Input**  
Choose your input device

Avantree Eon

Sound

**Output**  
Select a device for sound output:

Avantree Eon

**Input**  
Select a device for sound input:

Avantree Eon

**Passo 2:**

Ripeti i passaggi precedenti nel tuo software per riunioni (ad es. Teams, Zoom, Skype, ecc.)

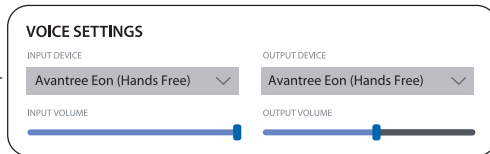
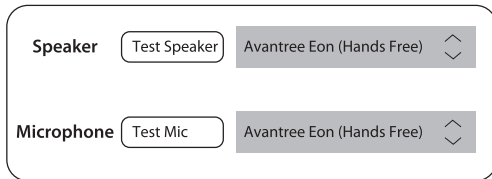
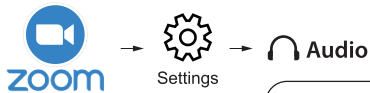
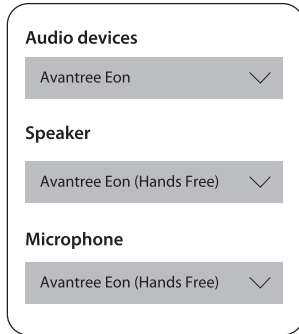
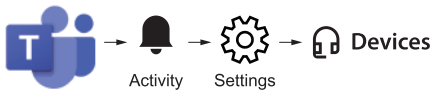

*NOTA: Su Windows 11 / macOS, non è disponibile l'opzione "Vivavoce"; seleziona invece "Avantree Eon" come predefinito.*

## Chiamare con il Microfono

Le cuffie Eon hanno un microfono incorporato, ma l'utilizzo del microfono a braccio staccabile migliorerà notevolmente la qualità della tua chiamata. La sua tecnologia di filtraggio del rumore assicurerà che la tua voce (e solo la tua voce) sia udita forte e chiara e il suo interruttore mute può essere utilizzato comodamente.

Ti consigliamo vivamente di utilizzare il microfono ad asta per le tue chiamate. Puoi usarlo sia in modalità wireless che cablata collegandolo alle cuffie e (facoltativamente) collegando il cavo AUX direttamente al microfono ad asta.

## Utilizzo come Cuffie Cablate

### Passo 1

Muovere il tasto  sulla posizione "OFF / Wired."

### Passo 2

#### OPZIONE 1

Se non hai bisogno del microfono, collega il cavo audio AUX da 3,5 mm sia alle cuffie che al dispositivo di uscita audio.

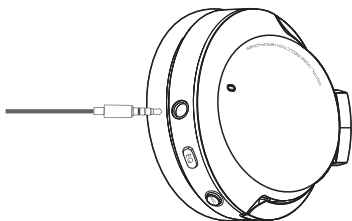

#### OPZIONE 2

Se desideri effettuare chiamate, collega prima il microfono con braccio staccabile alle cuffie, quindi collega il cavo audio AUX da 3,5 mm al microfono. Collega l'altra estremità del cavo al dispositivo di uscita audio.

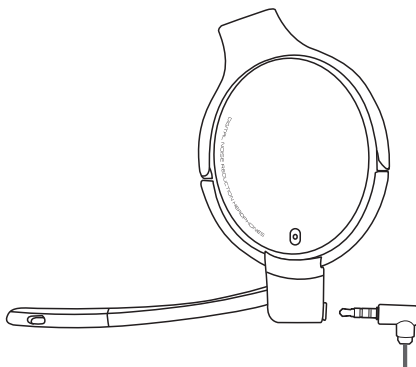

*NOTA: In modalità cablate, le modalità di ascolto (ANC, trasparenza, normale) e tutti gli altri pulsanti integrati non funzionano. L'interruttore sul microfono funzionerà comunque.*

## Sostituzione della Batteria Ricaricabile

Le batterie ricaricabili, situate in entrambe le cuffie, possono essere sostituite per prolungare la durata della tua Eon. Scansiona il codice QR qui sotto o cerca "Batteria Avantree Eon" su Amazon o sul sito web di Avantree per procedere all'acquisto.

IT

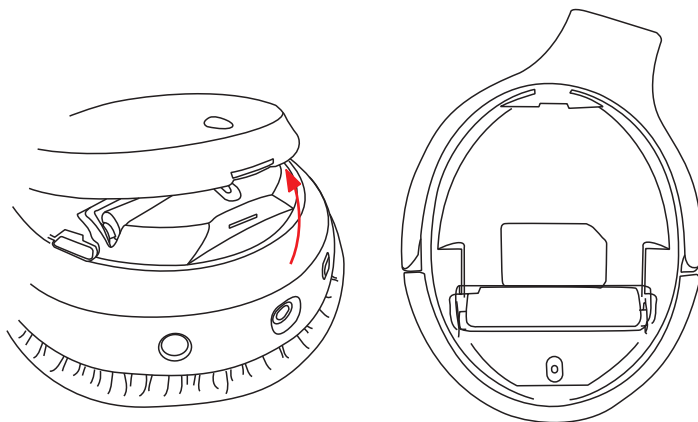

È inoltre possibile utilizzare batterie compatibili con le seguenti specifiche: Batteria ricaricabile 10440 agli ioni di litio da 3,7 V, capacità 350 mAh.

Visita [avantree.com/eon/replace-battery](https://avantree.com/eon/replace-battery) per le istruzioni di installazione e i dettagli dei venditori consigliati.





## Specifications

Versione Bluetooth	5.0
Codec Audio Supportati	AAC, SBC
Profili Supportati	HSP v1.2, HFP v1.7, AVRCP v1.6 and A2DP v1.3.1
Raggio di Connessione	Up to 50ft / 15m
Drivers	40mm
Impedenza	32Ω
Frequenza di Risposta	20Hz - 20KHz
Tempo di Ricarica	~2.5hrs
Tempo di Operatività	Fino a 45 ore (ANC disattivato)
Tempo di Standby	325 ore (ANC disattivato)
Pressione del Suono (SPL)	100dB (1kHz / 179MV)
Distorsione Armonica (THD)	<0.5% (1kHz)
Dimensioni	191mm x 156mm x 92mm
Peso delle Cuffie	~300g
Diametro Interno delle cuffie	68mm x 47mm / 35mm
Diametro Esterno delle cuffie	110mm x 90mm
Caricatore	DC5V/500mA~2.0A
Porta di Ricarica	Type C

## FAQ

Di seguito sono riportate alcune delle domande più comuni che le persone hanno durante l'installazione.

### Perché il microfono non funziona con il mio PC?

Ci sono diversi motivi per cui il microfono potrebbe non funzionare con il tuo PC. Prima di tutto, controlla il microfono ad asta per assicurarti che l'interruttore di disattivazione dell'audio sia disattivato (riattivato). Il problema potrebbe anche essere correlato all'hardware o alle impostazioni del computer. Per determinare se si tratta di un problema hardware, collega le cuffie al telefono e prova a chiamare qualcuno, provando sia con che senza il microfono ad asta. Se non ci sono problemi, ricontraolla le impostazioni del tuo computer.

- Assicurati che sia aperta una sola app per riunioni alla volta.
- Assicurati che le impostazioni del tuo PC siano impostate correttamente: controlla le impostazioni audio del tuo computer e assicurati che Eon sia selezionato sia come sorgente di output che di input. Controlla anche le impostazioni audio del tuo software per riunioni.
- Assicurati che non ci siano interferenze da un secondo dispositivo: se il tuo Eon è connesso contemporaneamente a un altro dispositivo tramite dual link, prova a disconnetterti dall'altro dispositivo.

### Perché il mio audio non passa dal telefono al PC con la funzione dual link?

Per passare dal telefono al PC, prima metti in pausa l'audio/termina la chiamata sul dispositivo corrente (utilizzando i controlli sul dispositivo attivo o premendo il pulsante corrispondente sulle cuffie). Dopo 7-10 secondi, avviare l'audio sul secondo dispositivo. L'Eon dovrebbe scambiare automaticamente le fonti.

Puoi trovare un elenco completo di domande frequenti su [avantree.com/support/eon](https://avantree.com/support/eon) o contattarci direttamente per ulteriore assistenza.

## Contattaci



**Supporto ticket**

[avantree.com/submit-a-ticket](https://avantree.com/submit-a-ticket)

---



**Email di supporto**

[support@avantree.com](mailto:support@avantree.com)

---



**USA / CA**

+1800 232 2078 (9am-6pm PST, Mon-Fri)

**UK**

+44 20 8068 2023 (9am-6pm, GMT, Mon-Sat)

**DE**

+49 32221097297 (11am-9pm, CET, Mon-Sat)

**FR**

+ 33 176340312 (11am-9pm, CET, Mon-Sat)

**IT**

+39 06 9480 3330 (9am-6pm, CET, Mon-Sat)

**ES**

+ 34 931786261 (9am-6pm, CET, Mon-Sat)

**AU**

+ 61 2 8310 9897 (11am-7pm, AEST, Mon-Fri)

---



**Domande frequenti (FAQ)**

[avantree.com/support/eon](https://avantree.com/support/eon)

---



**Registrazione del prodotto** [avantree.com/product-registration](https://avantree.com/product-registration)

# Contenidos

Contenidos de la Caja .....	67
Introducción del Producto .....	68
Descripción del producto .....	68
Función de las Teclas .....	69
Indicadores LED .....	70
Recargar los Auriculares .....	71
Conectar Auriculares a Dispositivos .....	72
Emparejamiento y Conexión .....	72
Configuración de Ajustes de Audio (solo para PC) .....	74
Llamar con Micrófono .....	76
Uso como un Auricular con Cable .....	77
Reemplazar la Batería Recargable .....	78
Especificaciones .....	79
FAQ .....	80
Contactos .....	81

## Contenido de la Caja

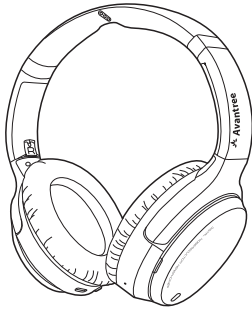

Auriculares Eon

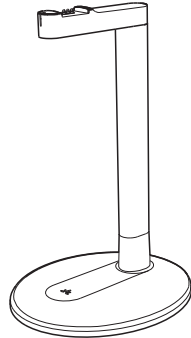

Base de carga

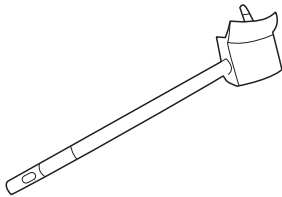

Micrófono Boom

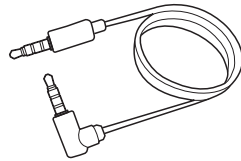

Cable de audio AUX de 3,5 mm

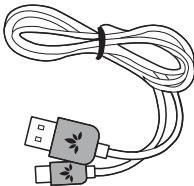

Cable de alimentación tipo C

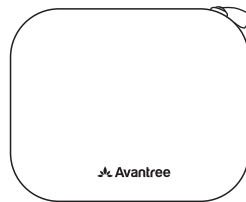

Maletín de transporte

# Introducción del Producto

## Descripción del Producto

3 Botón de modo ANC/Transparencia/Normal

B Indicador de modo de audición

4 Botón de Ecuilización

Conector AUX de 3,5 mm

C Indicador de Uso

1 ENCENDIDO/  
APAGADO  
Alámbrico/  
Conectado

A Indicador Estado







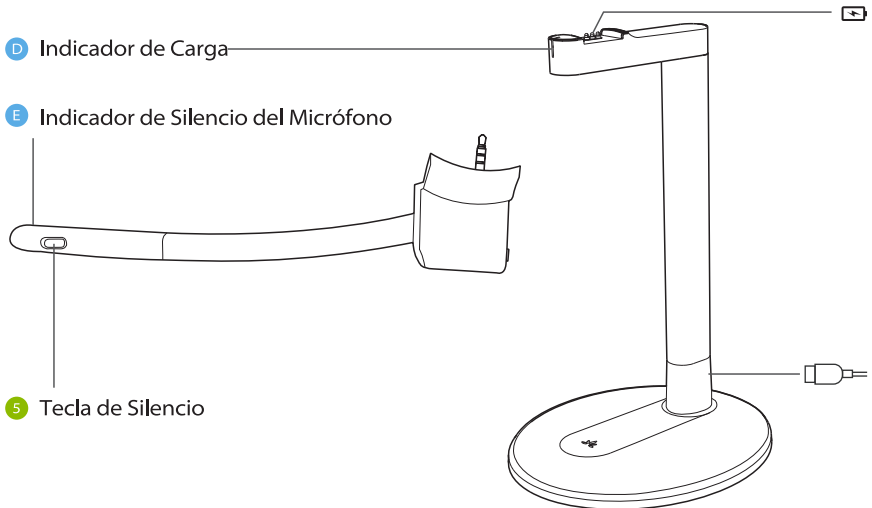
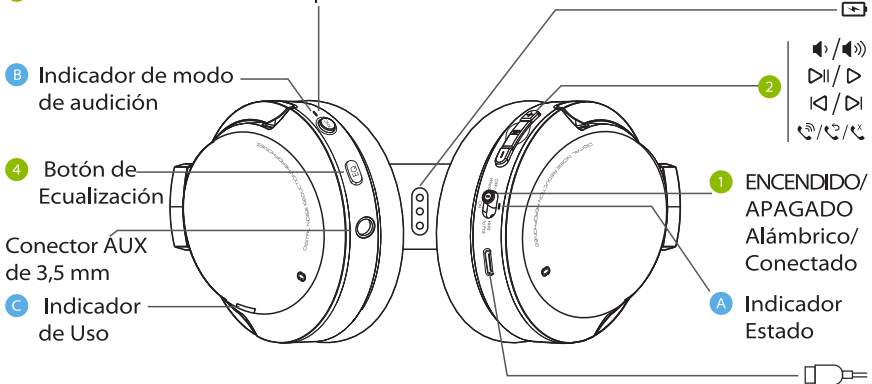

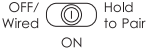

D Indicador de Carga

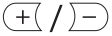
E Indicador de Silencio del Micrófono

5 Tecla de Silencio



## Button Functions

No.	Tecla	Función
1		Cambia a la posición "ON/OFF" para encender/apagar los auriculares.
		Cambie a la posición "WIRED" para usarlo como auricular con cable
		Cambie a la posición "HOLD TO PAIR" y manténgalo presionado durante 2 segundos para ingresar al modo de emparejamiento
2		Presione una vez para reproducir / pausar
		Presione una vez para aceptar / finalizar la llamada
		Mantenga presionado durante 2 segundos para rechazar la llamada
		Presione dos veces para volver a marcar el último número
		Presione una vez para aumentar/disminuir el volumen
		Mantenga presionado durante 2 segundos para saltar/reproducir la canción
	Mantenga presionados ambos botones durante 5 segundos para borrar el historial de emparejamiento	
	Presiona las teclas "  &  " juntos durante 1 segundo para activar/desactivar el efecto local (monitoreo de micrófono; escúchate hablar)	
3		Presione una vez para cambiar entre los modos Cancelación activa de ruido/Transparencia (escuche su entorno)/Normal.
4		Presione una vez para alternar entre los modos equilibrado y de refuerzo de graves
5	 (on boom mic)	Cambiar entre  /  para silenciar/reactivar el micrófono

## Indicatori LED

No.	Indicador y Mensaje de Voz	Estado
A	Rojo solido	Carga
	Rojo intermitente	Batería baja
	Azul intermitente, indicador de voz "BATERÍA ALTA / MEDIA / BAJA".	Encendido
	Rojo fijo durante 1 segundo y luego apagado, mensaje de voz "GOODBYE".	Apagado
	Rojo y azul parpadeando alternativamente, mensaje de voz "PAIRING".	Emparejamiento
	Parpadeo azul cada 5 segundos, indicador de voz "CONECTADO".	Conexión
	Parpadeo azul cada 2 segundos, indicador de voz "DESCONECTADO".	Desconexión
	Rosa fijo durante 5 segundos, luego se alternan destellos rojos y azules	Historial de conexiones eliminado
B	Verde fijo, indicador de voz "NOISE CANCELING".	Modo de Cancelación Activa de Ruído (ANC).
	Parpadeando en verde cada 5 segundos, mensaje de voz "TRANSPARENCY".	Modo de transparencia
	LED apagado, indicador de voz "NORMAL".	Modo normal
C	Rojo sólido	En llamada
D	Blanco fijo	Carga
	Verde solido	Carga completa
E	Rojo sólido	Silenciar micrófono



## Recargar

Un mensaje de voz "LOW BATTERY" y una luz roja parpadeante indicarán que la batería está baja. Para cargar, puede utilizar un adaptador USB de 5 V/500 mA-2 A (el cargador de teléfono o similar debería funcionar) o un puerto USB de PC como fuente de alimentación.

### OPCIÓN 1 Carga con soporte

Coloque los auriculares en el soporte de carga. El LED de la base de carga se volverá blanco durante la carga y se volverá verde cuando se complete la carga.

### OPCIÓN 2 Carga con cable USB

Como alternativa, puede enchufar el cable de alimentación tipo C incluido directamente en el puerto de carga de los auriculares.

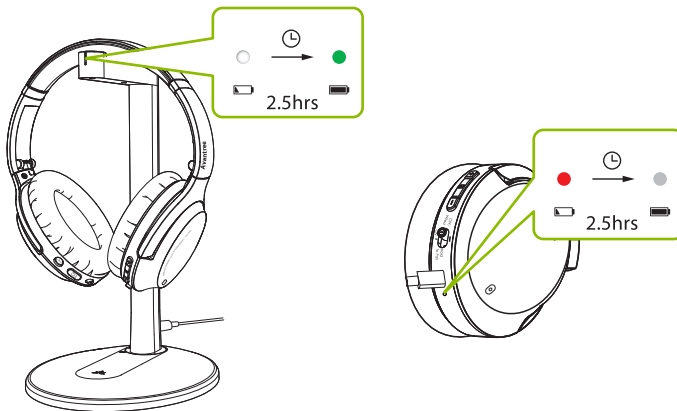

Una luz roja fija indica que la carga está en curso; una vez que la luz se apague, sus auriculares estarán completamente cargados.

# Conexión de los Auriculares al Dispositivo

## Emparejamiento y conexión

### PASO 1

Enciende los auriculares. Al usarlos por primera vez, los auriculares entrarán automáticamente en modo PAIRING. Si no, pon los auriculares en modo PAIRING

deslizando la tecla  Hold to Pair en la posición "HOLD TO PAIR" durante 2 segundos hasta que el LED parpadee en rojo y azul.

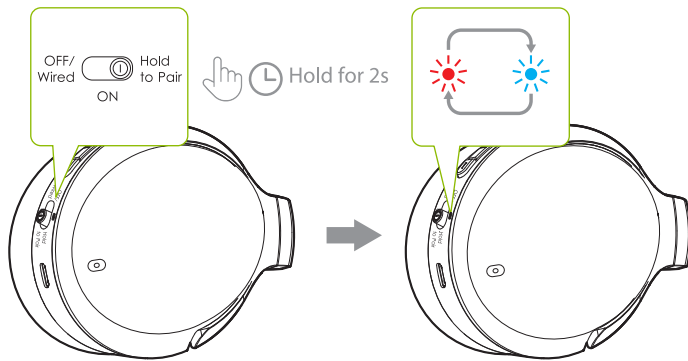



### PASO 2

Enciende el Bluetooth de su dispositivo y seleccione "Avantree Eon" en el menú de Bluetooth.

### PASO 3

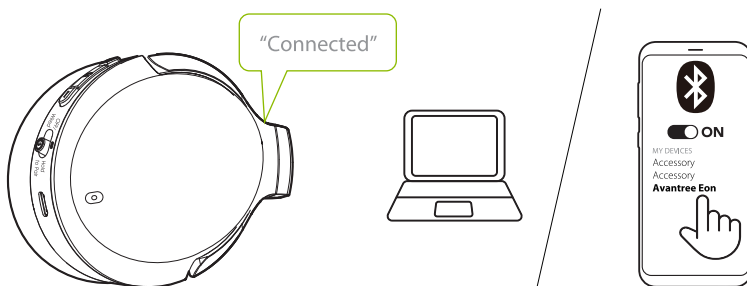
Sostenga los auriculares cerca de su dispositivo y espere de 5 a 10 segundos o hasta que se conecten. Una vez conectado correctamente, el indicador LED de los auriculares parpadeará en azul y escuchará el mensaje de voz "CONECTADO".



Para un uso posterior, los auriculares deberían volver a conectarse automáticamente al último dispositivo emparejado unos segundos después de encenderlos. De lo contrario, puede activar manualmente la reconexión deslizando la tecla  OFF/Wired ON Hold To Pair en la posición "HOLD TO PAIR" una vez, o seleccionando "Avantree Eon" en el menú Bluetooth de su dispositivo.

## Configuración de ajustes de audio (solo para PC)

Es posible que deba configurar sus ajustes de audio cuando utilice el Eon con su PC o computadora portátil.

### PASO 1

Acceda a la configuración de audio de su dispositivo y configure "Avantree Eon" como predeterminado en SALIDA DE AUDIO / REPRODUCCIÓN. Configure "Avantree Eon" como predeterminado en ENTRADA / DISPOSITIVO DE MICRÓFONO.

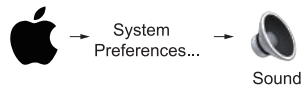
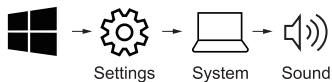

**Sound**

**Output**  
Choose your output device

Avantree Eon ▾

**Input**  
Choose your input device

Avantree Eon ▾

**Sound**

**Output**  
Select a device for sound output:

Avantree Eon

**Input**  
Select a device for sound input:

Avantree Eon

**PASO 2:**

Repita los pasos anteriores en su software de reuniones (por ejemplo, Teams, Zoom, Skype, etc.)

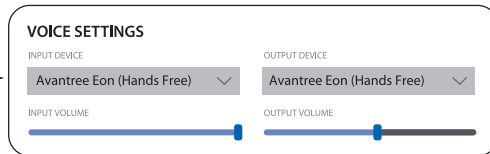
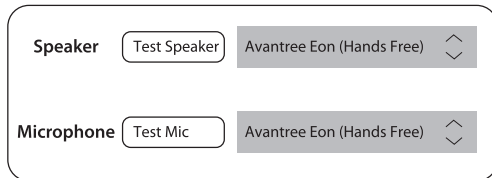
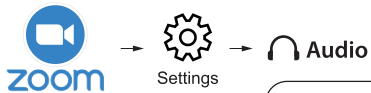
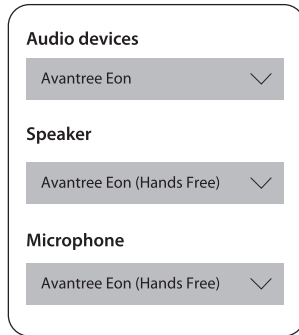
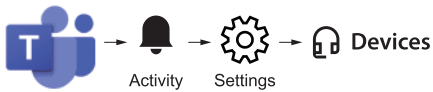

*NOTA: En Windows 11 / macOS, la opción "Altavoz" no está disponible; seleccione "Avantree Eon" como el valor predeterminado en su lugar.*

## Llamar con Micrófono

Los auriculares Eon tienen un micrófono incorporado, pero el uso del micrófono boom desmontable mejorará en gran medida la calidad de su llamada. Su tecnología de filtrado de ruido garantizará que su voz (y solo su voz) se escuche alto y claro, y su interruptor de silencio se puede operar convenientemente.

Le recomendamos encarecidamente que utilice el micrófono boom para sus llamadas. Puede usarlo tanto de forma inalámbrica como con cable conectándolo a los auriculares y (opcionalmente) conectando el cable AUX directamente al micrófono boom.

## Uso como un Auricular con Cable

### PASO 1

Mueva la llave  a la posición "OFF/WIRED".

### PASO 2

#### OPCIÓN 1

Si no necesita el micrófono, conecte el cable de audio AUX de 3,5 mm tanto a los auriculares como al dispositivo de salida de audio.

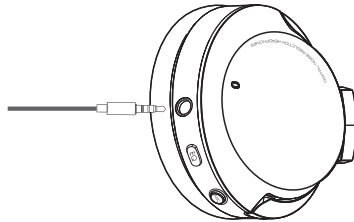

#### OPCIÓN 2

Si desea realizar llamadas, conecte primero el micrófono boom desmontable a los auriculares y luego conecte el cable de audio AUX de 3,5 mm al micrófono. Conecta el otro extremo del cable a tu dispositivo de salida de audio.

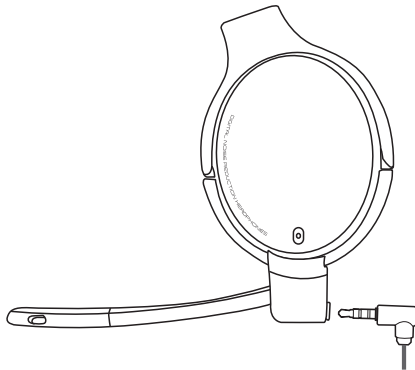

**NOTA:** En el modo con cable, los modos de audición (ANC, transparencia, normal) y todos los demás botones integrados no funcionan. El interruptor del micrófono seguirá funcionando.

## Reemplazo de la Batería Recargable

Las baterías recargables, ubicadas en ambos auriculares, se pueden reemplazar para prolongar la vida útil de su Eon. Escanee el código QR a continuación o busque "Avantree Eon Battery" en Amazon o en el sitio web de Avantree para comprar.

ES

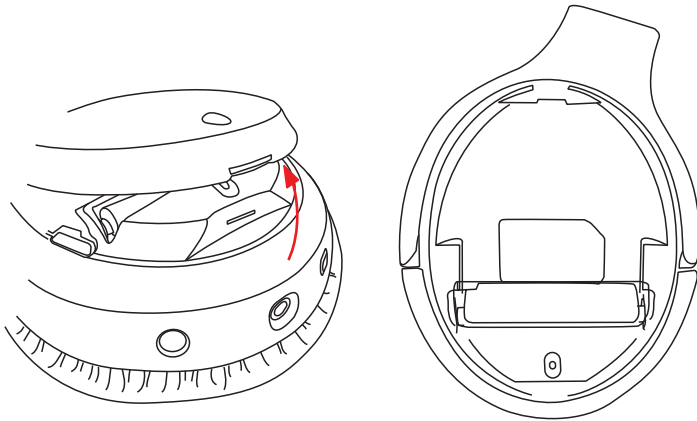

También puede utilizar baterías compatibles con las siguientes especificaciones: batería recargable de iones de litio 3,7 V 10440, capacidad de 350 mAh.

Visite [avantree.com/eon/replace-battery](https://avantree.com/eon/replace-battery) para obtener instrucciones de instalación y detalles de los vendedores recomendados.





## Specifiche

Versión Bluetooth	5.0
Códecs de Audio compatibles	AAC, SBC
Perfiles Compatibles	HSP v1.2, HFP v1.7, AVRCP v1.6 and A2DP v1.3.1
Radio de Conexión	Hasta a 15m
Drivers	40mm
Impedancia	32Ω
Frecuencia de Respuesta	20Hz - 20KHz
Tiempo de recarga	~2.5hrs
Tiempo de funcionamiento	Hasta 45 horas (ANC desactivado)
Tiempo en Standby	325 horas (ANC desactivado)
Presión de sonido (SPL)	100dB (1kHz / 179MV)
Distorsión armónica (THD)	<0.5% (1khz)
Dimensiones	191mm x 156mm x 92mm
Peso de los Auriculares	~300g
Diámetro interno de los Auriculares	68mm x 47mm / 35mm
Diámetro exterior de los Auriculares	110mm x 90mm
Cargador	DC5V/500mA~2.0A
Puerto de Carga	Type C

## FAQ

A continuación se presentan algunas de las preguntas más comunes que la gente tiene al instalar.

### **Por qué el micrófono no funciona con mi PC?**

Hay varias razones por las que el micrófono puede no funcionar con su PC. Primero, verifique el micrófono boom para asegurarse de que el interruptor de silencio esté apagado (no silenciado). El problema también podría estar relacionado con el hardware o la configuración de su computadora. Para determinar si se trata de un problema de hardware, conecte los auriculares a su teléfono e intente llamar a alguien, con y sin el micrófono boom. Si no hay problemas, vuelva a verificar la configuración de su computadora.

- Asegúrese de que solo una aplicación de reunión esté abierta a la vez.
- Asegúrese de que la configuración de su PC esté configurada correctamente: verifique la configuración de audio de su computadora y asegúrese de que Eon esté seleccionado como fuente de entrada y salida. Compruebe también la configuración de audio de su software de reuniones.
- Asegúrese de que no haya interferencias de un segundo dispositivo: si su Eon está conectado a otro dispositivo a través de un enlace dual al mismo tiempo, intente desconectarse del otro dispositivo.

### **Por qué mi audio no pasa del teléfono a la PC con la función de doble enlace?**

Para cambiar entre el teléfono y la PC, primero pause/finalice la llamada en el dispositivo actual (ya sea usando los controles en el dispositivo activo o presionando el botón correspondiente en el auricular).

Después de 7 a 10 segundos, inicie el audio en el segundo dispositivo. El Eon debería intercambiar fuentes automáticamente.

Puede encontrar una lista completa de preguntas frecuentes en [avantree.com/support/eon](https://avantree.com/support/eon) o contáctenos directamente para obtener más ayuda.

## Contattaci



**Soporte por ticket**

[avantree.com/submit-a-ticket](https://avantree.com/submit-a-ticket)



**Soporte por correo electrónico**

[support@avantree.com](mailto:support@avantree.com)



**USA / CA**

+1800 232 2078 (9am-6pm PST, Mon-Fri)

**UK**

+44 20 8068 2023 (9am-6pm, GMT, Mon-Sat)

**DE**

+49 32221097297 (11am-9pm, CET, Mon-Sat)

**FR**

+ 33 176340312 (11am-9pm, CET, Mon-Sat)

**IT**

+39 06 9480 3330 (9am-6pm, CET, Mon-Sat)

**ES**

+ 34 931786261 (9am-6pm, CET, Mon-Sat)

**AU**

+ 61 2 8310 9897 (11am-7pm, AEST, Mon-Fri)



**Preguntas frecuentes**

[avantree.com/support/eon](https://avantree.com/support/eon)



**Registro del producto**

[avantree.com/product-registration](https://avantree.com/product-registration)

# 目次

箱の内容	83
製品概要	84
各部名称	84
ボタンの操作	85
LEDインジケーター	86
ヘッドホンを充電する	87
ヘッドホンをデバイスに接続する	88
ペアリングと接続	88
オーディオの設定を行う（PCのみ）	90
ブームマイクで通話する	92
有線ヘッドホンとして使用する	93
リチャージャブルバッテリーを交換する	94
製品仕様	95
FAQ よくあるご質問（FAQ）	96
お問い合わせ	97

## 箱の内容

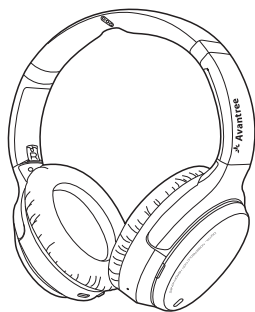

Eonヘッドホン

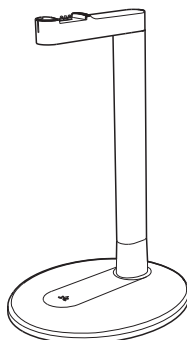

充電スタンド

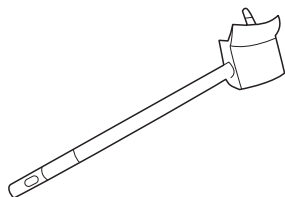

ブームマイク

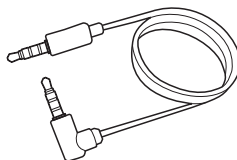

3.5mm AUXオーディオケーブル

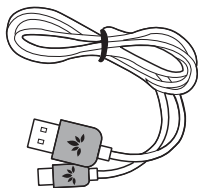

Type-C電源ケーブル

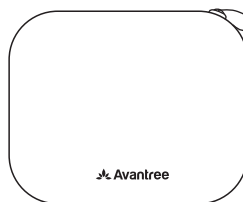

キャリングケース

jp

# 製品概要

## 各部名称

③ ANC / トランスペアレンシー / 通常モードボタン

② リスニングモード  
インジケータ

④ EQモード  
ボタン

Conector AUX  
de 3,5 mm

① ビジーライト

② ON / OFF /  
Wired / PAIR  
= ON / OFF /  
有線 / ペアリ  
ング







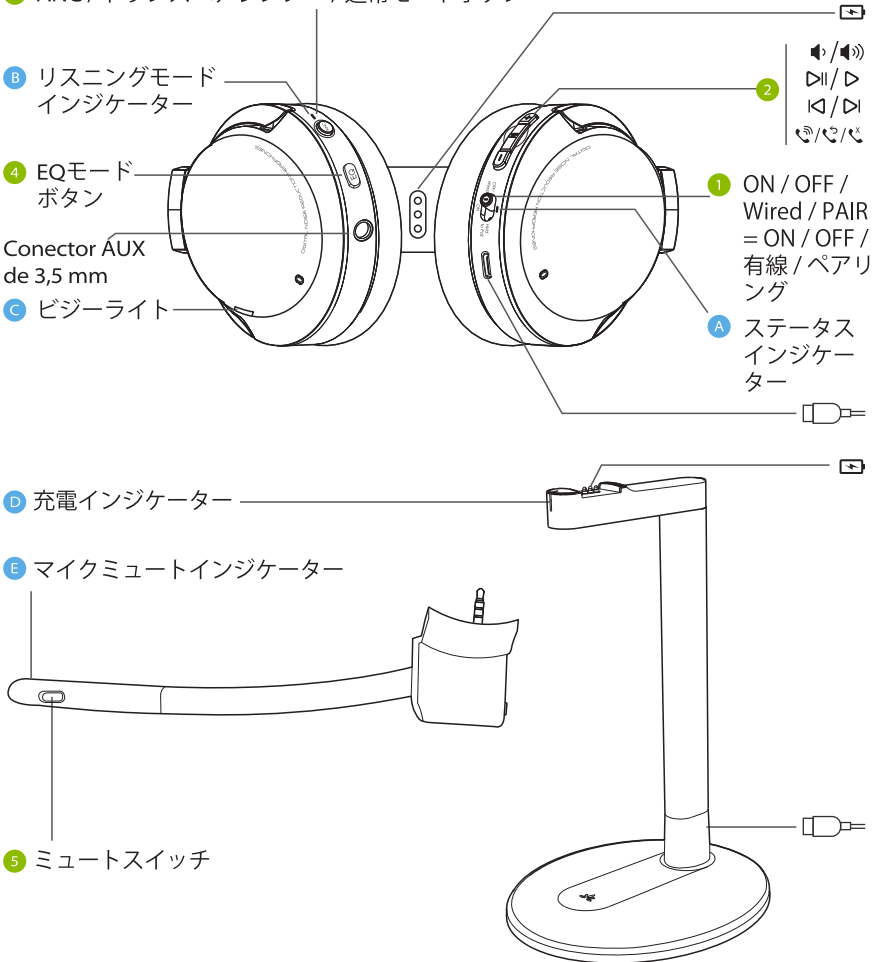

③ ステータス  
インジケー  
ター

④ 充電インジケータ

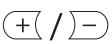
⑤ マイクミュートインジケータ

⑥ ミュートスイッチ



No.	ボタン	操作方法
1		スイッチを「ON / OFF」の位置に合わせると、ヘッドホンがオン/オフになります
		有線ヘッドホンとして使用する場合は、スイッチを「Wired」の位置に合わせます
		スイッチを「Hold to Pair」の位置に合わせて2秒間長押しすると、ペアリングモードになります
2		1回押すと、再生 / 一時停止します
		1回押すと、通話を受信 / 終了します
		2秒長押しすると、通話を拒否します
		2回押すと、最後にかけた番号に再ダイヤルします
		1回押すと、音量が大きく / 小さくなります
		2秒間長押しすると、曲をスキップ / リプレイします
	両ボタンを5秒間長押しすると、ペアリング履歴が消去されます	
3		1回押すと、アクティブノイズキャンセリング / トランスペアレンシー (周囲の音が聞こえる) / 通常モードに切り替わります
		1回押すと、バランスモードとバスブーストモードに切り替わります
4		1回押すと、バランスモードとバスブーストモードに切り替わります
5		スイッチを  /  の位置に合わせると、マイクがミュート解除 / ミュートになります

## LEDインジケータ

No.	インジケータと音声プロンプト	ステータス
A	赤色点灯	充電中
	赤色点滅	バッテリー残量低下
	青色点滅、「BATTERY HIGH / MEDIUM / LOW」音声ガイダンス	電源オン
	赤色で1秒間点灯後消灯、「GOODBYE」音声ガイダンス	電源オフ
	赤と青色の交互点滅、「PAIRING」音声ガイダンス	ペアリング中
	5秒ごとに青色点滅、「CONNECTED」音声ガイダンス	接続済み
	2秒ごとに青色点滅、「DISCONNECTED」音声ガイダンス	接続解除済み
	ピンク色で5秒間点灯後、赤と青色の交互点滅	ペアリング履歴消去中
B	緑色点灯、「NOISE CANCELING」音声ガイダンス	アクティブノイズキャンセリング(ANC)モード
	5秒ごとに緑色点滅、「TRANSPARENCY」音声ガイダンス	トランスペアレンシーモード
	LED消灯、「NORMAL」音声ガイダンス	通常モード
C	赤色点灯	通話中
D	白色点灯	充電中
	緑色点灯	充電完了
E	赤色点灯	マイクミュート済み



## ヘッドホンを充電する

「BATTERY LOW」の音声ガイダンスと **A** の赤色点滅で、バッテリー残量が少ないことを示します。充電には、5V/500mA-2A USBアダプター (携帯電話の充電器などが使用可能) またはPCのUSBポートを電源として使用することができます。

### オプション1 スタンドで充電する

ヘッドホンを充電スタンドに置きます。充電中は充電ドックのLEDが白色に点灯し、充電が完了すると緑色に点灯します。

### オプション2 USBケーブルで充電する

付属のType-C電源ケーブルをヘッドホンの充電ポートに直接差し込みます。

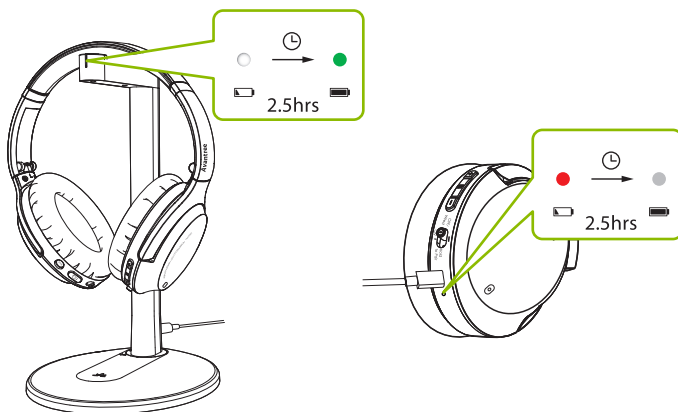

赤色の点灯は充電中であることを示し、消灯するとヘッドホンのバッテリーが完全に充電されたことを示します。

# ヘッドホンをデバイスに接続する

## ペアリングと接続

### ステップ 1

ヘッドホンの電源をオンにします。初めて使用する場合、ヘッドホンは自動的にペアリングモードになります。

ペアリングされない場合は、<sup>OFF/Wired</sup>  <sup>Hold to Pair</sup> スイッチを「Hold to Pair」にスライドさせて、LEDが赤と青に点滅するまで2秒間押し続けてヘッドホンをペアリングモードにします。

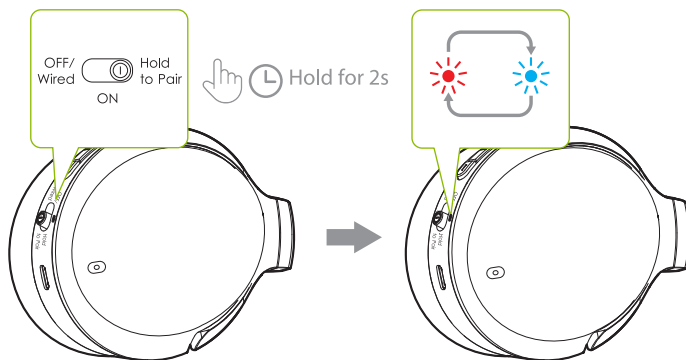



### ステップ 2

デバイスのBluetoothをオンにし、Bluetoothメニューで「Avantree Eon」を選択します。

### ステップ 3

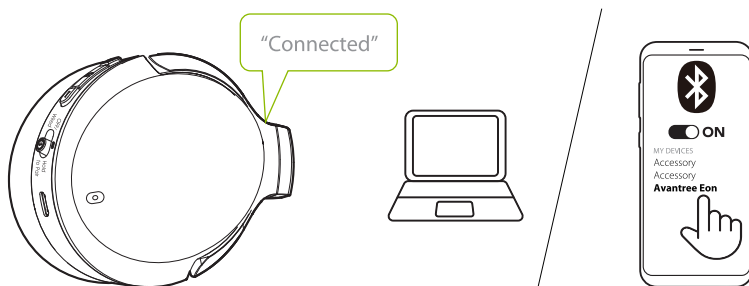
ヘッドホンをデバイスに近づけ、5~10秒または接続するまで待ちます。正常に接続されると、ヘッドホンのLEDインジケーターが青く点滅し、「CONNECTED」という音声ガイダンスが聞こえます。



初回以降は、ヘッドホンの電源を入れてから数秒以内に、最後にペアリングしたデバイスに自動的に再接続します。接続されない場合は、 OFF/Wired  Hold To Pair  
ON

スイッチを1回「Hold to Pair」にスライドさせるか、デバイスのBluetoothメニューで「Avantree Eon」を選択することで、手動で再接続を有効にすることができます。

## オーディオの設定を行う（PCのみ）

PCまたはラップトップで Eon を使用する場合、オーディオ設定を構成する必要がある場合があります。

### ステップ 1

デバイスのオーディオ設定にアクセスし、「音声出力 / 再生」で「Avantree Eon」をデフォルトに設定します。入力 / マイクで「Avantree Eon」をデフォルトに設定します。

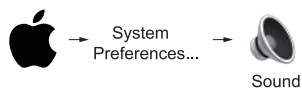
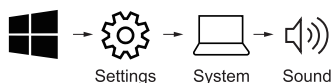

**Sound**

**Output**  
Choose your output device

Avantree Eon ▾

**Input**  
Choose your input device

Avantree Eon ▾

**Sound**

**Output**  
Select a device for sound output:

Avantree Eon

**Input**  
Select a device for sound input:

Avantree Eon

## ステップ 2:

お使いのビデオ会議ソフトウェア（Teams、Zoom、Skypeなど）で上記の手順を繰り返します。

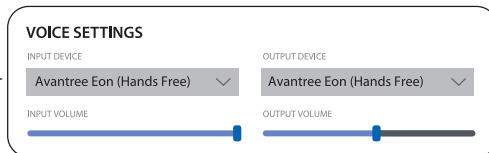
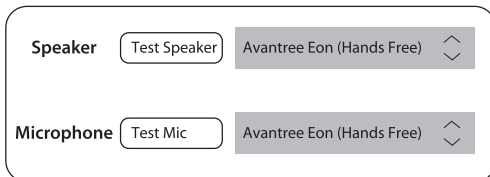
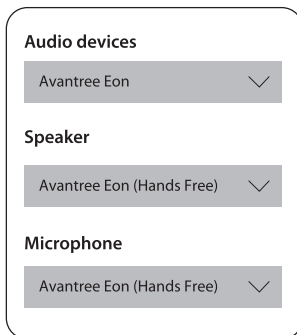
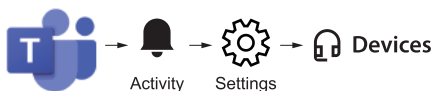

注意: Windows 11/macOSでは、「ハンズフリー」オプションはありません。代わりに「Avantree Eon」をデフォルトとして選択してください。

## ブームマイクで通話する

Eonヘッドホンにはマイクが内蔵されていますが、着脱式のブームマイクを使用することで、通話品質を大幅に向上させることができます。ノイズフィルタリング技術により、あなたの声(だけ)をはっきりと聞き取ることができます。ミュートスイッチも活用できます。

通話にはブームマイクの使用を強くお勧めします。ヘッドホンに接続し、(オプションで)AUXケーブルをブームマイクに直接接続することで、ワイヤレスと有線の両方のモードで使用することができます。

## 有線ヘッドホンとして使用する

### ステップ 1

OFF/Wired (ON) Hold to Pair スイッチを「OFF / Wired」にスライドさせます。

### ステップ 2

#### オプション 1

マイクが不要な場合は、3.5mm AUXオーディオケーブルを、ヘッドホンと音声出力デバイスの両方に差し込みます。

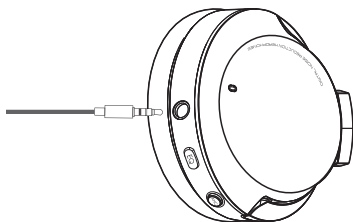

#### オプション 2

通話する場合は、まず着脱式のブームマイクをヘッドホンに差し込み、次に3.5mm AUXオーディオケーブルをマイクに差し込みます。ケーブルのもう一方は、お使いの音声出力デバイスに差し込みます。

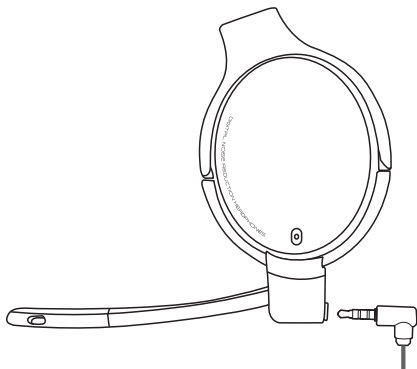

注意: 有線モードでは、リスニングモード (ANC、トランスペアレンシー、通常) および他のすべての内蔵ボタンは機能しません。ブームマイクのスイッチはそのまま機能します。

## リチャージャブルバッテリーを交換する

ヘッドホン両耳にある充電電池を交換することで、Eonの寿命を延ばすことができます。購入するには、下記のQRコードを読み取るか、AmazonやAvantreeのサイトで「Avantree Eon battery」と検索してください。

JP

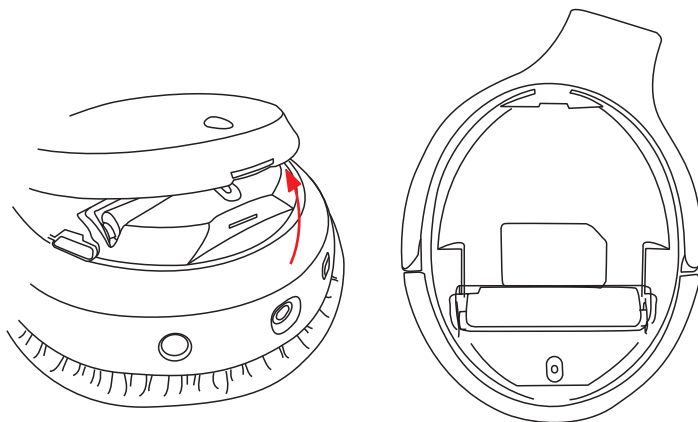

また、以下の仕様の互換バッテリーを使用することも可能です。

リチウムイオン10440充電電池 3.7V 容量: 350mAh

設置方法と推奨販売店の詳細については、[avantree.com/eon/replace-battery](https://avantree.com/eon/replace-battery)をご覧ください。





## 製品仕様

Bluetoothのバージョン	5.0
対応音声コーデック	AAC, SBC
対応プロファイル	HSP v1.2, HFP v1.7, AVRCP v1.6 and A2DP v1.3.1
動作範囲	最大50ft / 15m
ドライバー	40mm
インピーダンス	32Ω
周波数特性	20Hz - 20KHz
充電時間	約2.5時間
駆動時間	最大45時間 (ANCオフ時)
待機時間	325時間 (ANCオフ時)
音圧レベル (SPL)	100dB (1kHz / 179MV)
全高調波歪率 (THD)	<0.5% (1kHz)
製品サイズ	191mm x 156mm x 92mm
ヘッドホン重量	~300g
イヤークッション内径/深さ	68mm x 47mm / 35mm
イヤークッション外径	110mm x 90mm
電源	DC5V/500mA~2.0A
電源ポート	Type C

## FAQ よくあるご質問 (FAQ)

セットアップ時によくある質問を以下にご紹介します。

### 私のPCでマイクが使えないのはなぜですか？

マイクがPCと連動しない理由はいくつかあります。まず第一に、ブームマイクのミュートスイッチがOFF(ミュート解除)になっていることを確認してください。この問題は、ハードウェアまたはコンピュータの設定に関連している可能性もあります。ハードウェアの問題かどうかを判断するには、ヘッドホンを携帯電話に接続し、ブームマイクを使用する場合と使用しない場合の両方を試して、誰かに電話をかけるテストを行ってください。問題がない場合は、コンピュータの設定を再度確認してください。

- 一度に開く会議アプリは1つだけにしてください。
- PCの設定が正しく行われていることを確認します。PCのサウンド設定を確認し、Eonが出力と入力の両方のソースとして選択されていることを確認します。会議ソフトウェアのサウンド設定も確認してください。
- 他のデバイスからの干渉がないことを確認してください。Eonがデュアルリンクで他のデバイスと同時に接続されている場合、他のデバイスとの接続を解除してみてください。

### デュアルリンク機能で、スマホとPCの間で音声切り替わらないのはなぜですか？

携帯電話とPCを切り替えるには、まず現在のデバイスで音声を一時停止し、通話を終了します(有効なデバイスのコントロールを使用するか、ヘッドフォンの対応するボタンを押します)。

7~10秒後、2台目のデバイスで音声を開始します。Eonは自動的にソースを切り替えるはずですが。

FAQの一覧は[avantree.com/support/eon](http://avantree.com/support/eon)でご覧いただけます。また、追加のサポートについては直接お問い合わせください。

## お問い合わせ



サポートチケット

[avantree.com/submit-a-ticket](https://avantree.com/submit-a-ticket)

サポートメール

[support@avantree.com](mailto:support@avantree.com)

USA / CA

+1800 232 2078 (9am-6pm PST, Mon-Fri)

UK

+44 20 8068 2023 (9am-6pm, GMT, Mon-Sat)

DE

+49 32221097297 (11am-9pm, CET, Mon-Sat)

FR

+ 33 176340312 (11am-9pm, CET, Mon-Sat)

IT

+39 06 9480 3330 (9am-6pm, CET, Mon-Sat)

ES

+ 34 931786261 (9am-6pm, CET, Mon-Sat)

AU

+ 61 2 8310 9897 (11am-7pm, AEST, Mon-Fri)



FAQ

[avantree.com/support/eon](https://avantree.com/support/eon)

製品登録

[avantree.com/product-registration](https://avantree.com/product-registration)

Manufacturer: Avatronics Limited

Address: Luohu District, Shenzhen 518000 China

US Importer:

Avantree Corporation

San Jose, California 95119 USA

UK Importer:

Avantree Limited

Watford, WD180 0HQ UK



Servicer in Europe:

Gizmex GmbH,

Sternstr. 67, 40479 Dusseldorf, Germany

Tel: 01 – 408 334 8648 support@avantree.com



Model No: BTHS-AS100  
Dispose of the packaging and this product in accordance with the latest provisions.  
Z-PKQG-AS100-V2