

EON B

User Manual



Model No.: BTHS-AS100-B

Contents

EN	User Manual	2
DE	Benutzerhandbuch	17
FR	Manuel de l'utilisateur	32
IT	Manuale utente	47
ES	Manual del usuario	62
JP	取扱説明書	77

Table of Contents

Box Contents	3
Product Introduction	4
Product Overview	4
Button Functions	5
LED Indicators	6
Charging the Headphones	7
Connecting the Headphones to Your Device	8
Pairing & Connecting	8
Configuring Audio Settings (only for PC)	10
Using as Wired Headphones	12
Replacing the Rechargeable Battery	13
Specifications	14
FAQ	15
Contact Us	16

Box Contents

EN

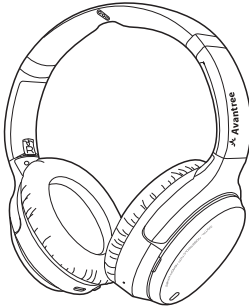

Eon B Headphones

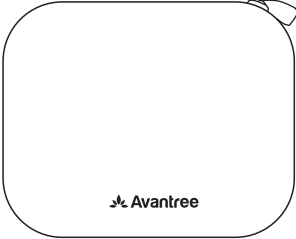

Carrying Case

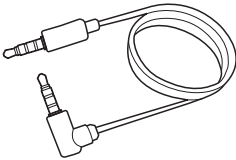

AUX 3.5mm Audio Cable

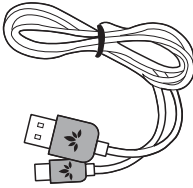

Type C Power Cable



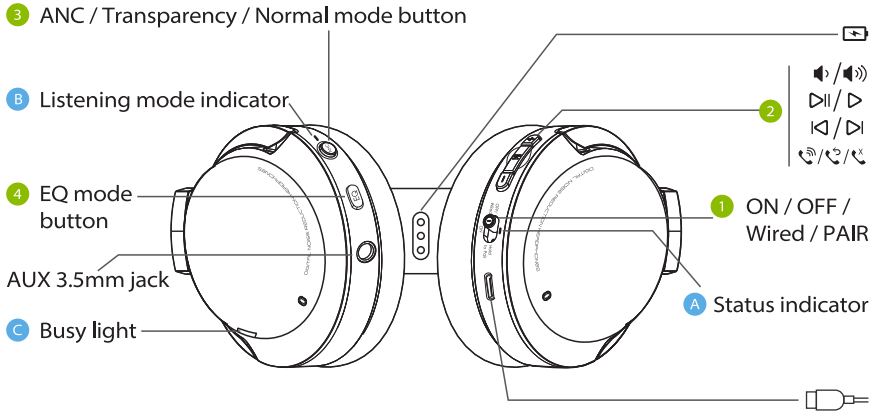

Product Introduction

Product Overview

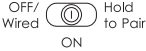

Button Functions

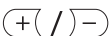
EN

No.	Button	Functions
1		Switch to the “ON / OFF” position to turn the headphones on / off
		Switch to the “WIRED” position to use as wired headphones
		Switch to the “HOLD TO PAIR” position & hold for 2 seconds to enter pairing mode
2		Press once to play / pause
		Press once to accept / end call
		Press & hold for 2 seconds to reject call
		Press twice to redial last number
		Press once to increase / decrease volume
		Press & hold for 2 seconds to skip / replay track
	Press & hold both buttons for 5 seconds to clear pairing history	
3		Press once to switch between Active Noise Cancellation / Transparency (hear your surroundings) / Normal modes.
4		Press once to switch between balanced and bass-boosted modes

LED Indicators

No.	Indicator & Voice Prompt	Status
A	Solid red	Charging
	Flashing red	Low battery
	Flashing blue, "BATTERY HIGH / MEDIUM / LOW" voice indicator	Power on
	Solid red for 1 second then off, "GOODBYE" voice indicator	Power off
	Alternate red & blue flashes, "PAIRING" voice indicator	Pairing
	Blue flash every 5 seconds, "CONNECTED" voice indicator	Connected
	Blue flash every 2 seconds, "DISCONNECTED" voice indicator	Disconnected
	Solid pink for 5 seconds, then alternate red & blue flashes	Clearing pairing history
B	Solid green, "NOISE CANCELING" voice indicator	Active Noise Cancellation (ANC) mode
	Green flash every 5 seconds, "TRANSPARENCY" voice indicator	Transparency mode
	LED off, "NORMAL" voice indicator	Normal mode
C	Solid red	In a call

Charging the Headphones

EN

A "BATTERY LOW" voice prompt and a flashing red **A** light will indicate low battery. In order to charge, you can use either a 5V/500mA-2A rated USB adapter (your phone charger or similar should work) or PC USB port as a power source.

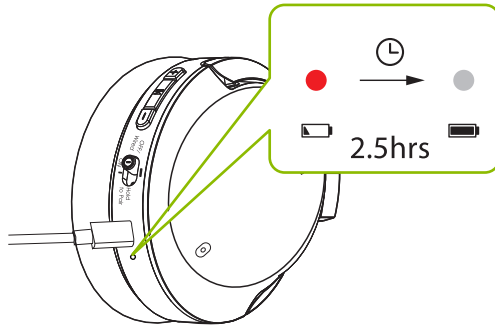

A solid red light indicates that charging is in progress; once the light turns off, your headphones will be at full battery.

Connecting the Headphones to Your Device

Pairing & Connecting

STEP 1

Turn on the headphones. For first time use, the headphones will enter PAIRING mode automatically.

If not, put your headphones into PAIRING mode by sliding the switch to "HOLD TO PAIR" and holding for 2 seconds until the LED flashes red & blue.

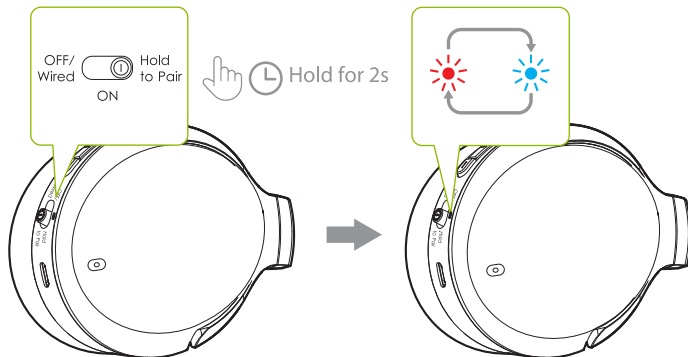

STEP 2

Turn on your device's Bluetooth and select "Avantree Eon" in the Bluetooth menu.

STEP 3

Keep the headphones close to your device and wait for 5-10 seconds or until they connect. Once they're successfully connected, the headphones' LED indicator will flash blue, and you'll hear a "CONNECTED" voice indicator.

EN

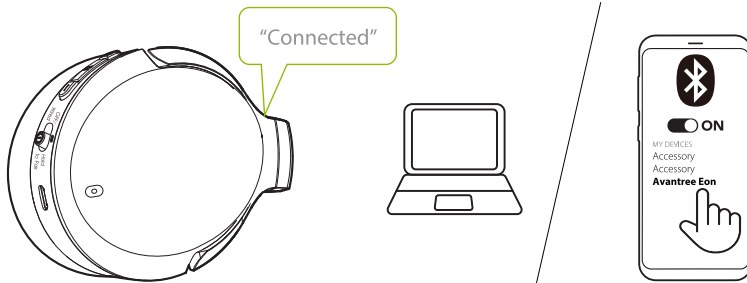

For subsequent use, your headphones should automatically reconnect to the last-paired device within a few seconds of being turned on. If not, you can manually activate reconnection by sliding the OFF/Wired  Hold to Pair ON switch to "HOLD TO PAIR" once, or by selecting "Avantree Eon" in your device's Bluetooth menu.

Configuring Audio Settings (only for PC)

You may need to configure your audio settings when using the Eon with your PC or laptop.

STEP 1

Access your device's audio settings and set "Avantree Eon" as the default in SOUND OUTPUT / PLAYBACK. Set "Avantree Eon" as the default in INPUT / MICROPHONE DEVICE.

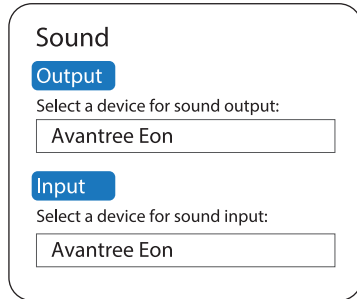
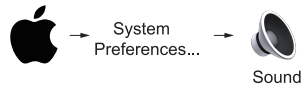
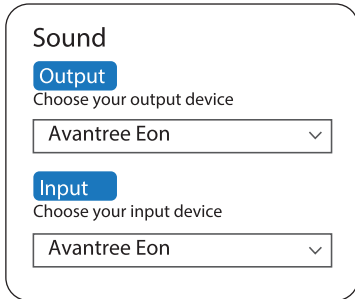
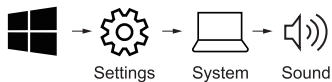

STEP 2:

Repeat the above steps in your meeting software (i.e. Teams, Zoom, Skype, etc.)

EN

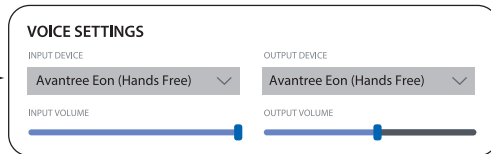
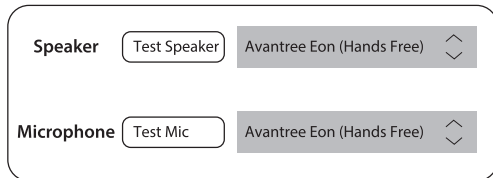
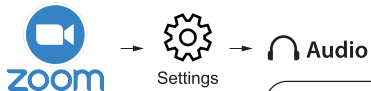
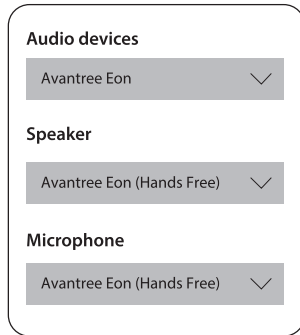
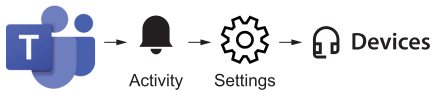

NOTE: On Windows 11 / macOS, there is no "Hands Free" option; select "Avantree Eon" as the default instead.

Using as Wired Headphones

STEP 1

Slide the  switch to "OFF / Wired."

STEP 2

Plug the AUX 3.5mm audio cable into both the headphones and your audio output device.

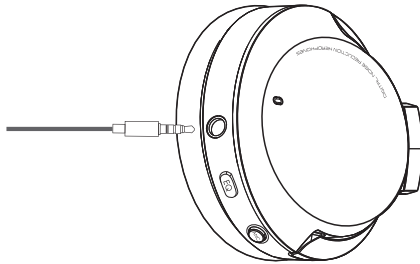

NOTE: When in wired mode, listening modes (ANC, transparency, normal) and all other built-in buttons do not function.

Replacing the Rechargeable Battery

EN

The rechargeable batteries, located in both headphones ears, can be replaced to extend your Eon's lifespan. Scan the QR code below or search "Avantree Eon battery" on Amazon or the Avantree website in order to purchase.

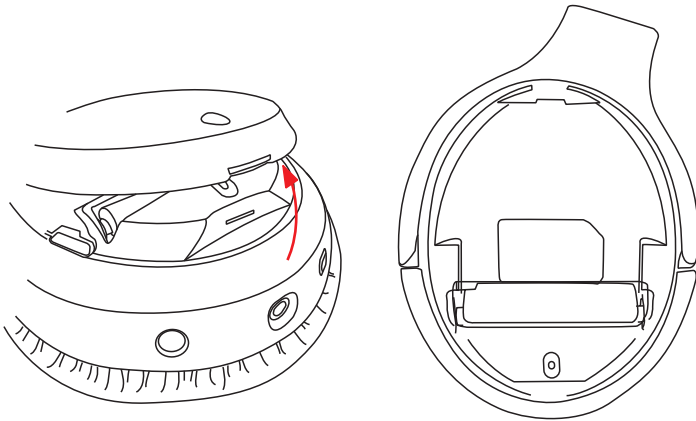

You can also use compatible batteries with the following specifications: 3.7V lithium ion 10440 rechargeable battery, capacity 350mAh.

Please visit avantree.com/eon/replace-battery for installation instructions and recommended sellers' details.



Specifications

Bluetooth version	5.0
Audio codec support	AAC, SBC
Supported profiles	HSP v1.2, HFP v1.7, AVRCP v1.6 and A2DP v1.3.1
Operating range	Up to 50ft / 15m
Drivers	40mm
Impedance	32Ω
Frequency response	20Hz - 20KHz
Charging time	~2.5hrs
Operating time	Up to 45hrs (ANC off)
Standby time	325hrs (ANC off)
Sound pressure level (SPL)	100dB (1kHz / 179MV)
Total harmonic distortion (THD)	<0.5% (1kHz)
Product size	191mm x 156mm x 92mm
Headphones weight	~300g
Earpads inner diameter / depth	68mm x 47mm / 35mm
Earpads outer diameter	110mm x 90mm
Rated Input	DC5V/500mA~2.0A
Power port	Type C

FAQ

Why isn't my audio switching between my phone and PC with the dual link feature?

To switch between your phone and your PC, first pause the audio / end the call on the current device (either by using the controls on your active device or by pressing the corresponding button on the headphones).

After 7-10 seconds, initiate audio on the second device. The Eon should automatically swap sources.

You can find a full FAQ list at avantree.com/support/eon-b, or contact us directly for additional assistance.

Contact Us



Support Tickets

avantree.com/submit-a-ticket



Support Email

support@avantree.com



USA / CA

+1800 232 2078 (9am-6pm PST, Mon-Fri)

UK

+44 20 8068 2023 (9am-6pm, GMT, Mon-Sat)

DE

+49 32221097297 (11am-9pm, CET, Mon-Sat)

FR

+ 33 176340312 (11am-9pm, CET, Mon-Sat)

IT

+39 06 9480 3330 (9am-6pm, CET, Mon-Sat)

ES

+ 34 931786261 (9am-6pm, CET, Mon-Sat)

AU

+ 61 2 8310 9897 (11am-7pm, AEST, Mon-Fri)



FAQ

avantree.com/support/eon-b

Inhaltsverzeichnis

Inhalt der Box	18
Produkteinführung	19
Produktübersicht	19
Tasten Funktionen	20
LED Anzeigen	21
Aufladen der Kopfhörer	22
Anschließen des Kopfhörers an Ihr Gerät	23
Koppeln und Verbinden	23
Konfigurieren der Audioeinstellungen (nur für PC)	25
Als kabelgebundene Kopfhörer verwenden	27
Auswechseln der wiederaufladbaren Batterie	28
Technische Daten	29
HÄUFIG GESTELLTE FRAGEN (FAQ)	30
Kontaktieren Sie uns	31

Inhalt der Box

DE

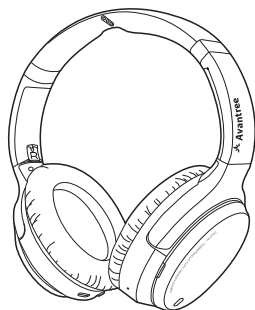

EON B Kopfhörer

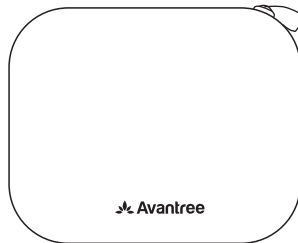

Tragetasche

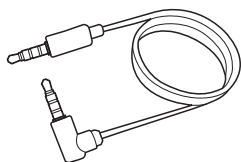

Aux 3,5 mm Audiokabel

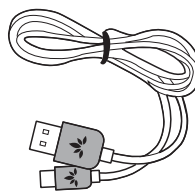

Typ C Netzkabel

Produkteinführung

Produktübersicht

3 Taste für ANC / Transperanz/Normalmodus

B Hörmodus-Anzeige

4 Taste für den EQ-Modus

AUX 3.5mm jack

C Busylight



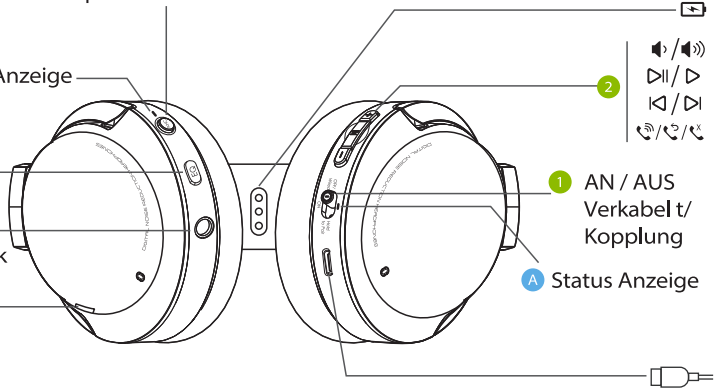

1 AN / AUS
Verkabelt/
Kopplung

A Status Anzeige

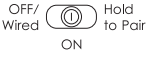

Tasten Funktionen

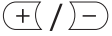
DE

Nr.	Taste	Funktionen
1		Stellen Sie den Schalter auf die Position "ON / OFF", um die Kopfhörer ein- oder auszuschalten
		Stellen Sie den Schalter auf die Position "WIRED", um die Kopfhörer als verkabelte Kopfhörer zu verwenden.
		Stellen Sie den Schalter auf die Position "HOLD TO PAIR" und halten Sie ihn 2 Sekunden lang gedrückt, um in den Pairing-Modus zu gelangen.
2		Einmal drücken, um die Wiedergabe zu starten / zu pausieren.
		Einmal drücken, um den Anruf anzunehmen / zu beenden.
		2 Sekunden lang gedrückt halten, um den Anruf abzulehnen.
		Zweimal drücken, um die letzte Nummer erneut zu wählen
		Einmal drücken, um die Lautstärke zu erhöhen / zu verringern.
		2 Sekunden lang gedrückt halten, um den nächsten / vorherigen Titel zu überspringen / wiederzugeben.
Beide Tasten 5 Sekunden lang gedrückt halten, um die Pairing-Historie zu löschen.		
3		Einmal drücken, um zwischen den Modi "Aktive Geräuschunterdrückung", "Transparenz" (Umgebungsgeräusche hören) und "Normal" zu wechseln.
4		Einmal drücken, um zwischen den Modi "Ausgeglichene Klangwiedergabe" und "Bass-Boost" zu wechseln.

LED Indicators

Nr.	Anzeige & Sprachansage	Status
A	Durchgehend rot leuchtend	Aufladung
	Rot blinkend	Schwache Batterie
	Blau blinkend Sprachausgabe "BATTERY HIGH / MEDIUM / LOW"	Einschalten
	Durchgehend rot leuchtend für 1 Sekunde und dann aus	Ausgeschaltet
	Blinkt abwechselnd rot und blau, Sprachanzeige "PAIRING".	Kopplung
	Blaues Blinken alle 5 Sekunden, Sprachanzeige "CONNECTED".	Verbunden
	Blaues Blinken alle 2 Sekunden, Sprachanzeige "DISCONNECTED"	Getrennt
	5 Sekunden durchgehend rosa, dann abwechselnd rotes und blaues Blinken	Kopplungsverlauf löschen
B	Durchgehend grün leuchtend , begleitet von der Sprachausgabe "NOISE CANCELING"	Aktive Geräuschunterdrückung (ANC)
	Grünes Blinken alle 5 Sekunden begleitet von der Sprachausgabe "TRANSPARENCY"	Transparenz-Modus
	LED aus, begleitet von der Sprachausgabe "NORMAL"	Normaler Modus
C	Durchgehend rot leuchtend	In einem Anruf

Aufladen der Kopfhörer

DE

Eine Sprachansage "BATTERY LOW" und ein rotes Blinken zeigen einen niedrigen Akkustand an. Zum Aufladen können Sie entweder einen 5V/500mA-2A USB-Adapter (Ihr Handy-Ladegerät oder ähnliches sollte funktionieren) oder einen PC-USB-Anschluss als Stromquelle verwenden.

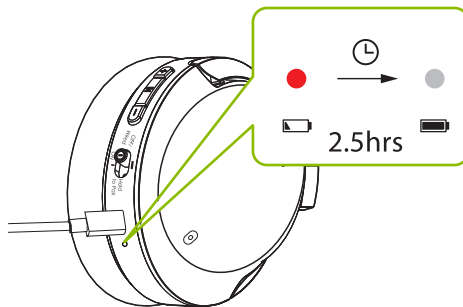

Eine durchgehend rote Leuchte zeigt an, dass der Ladevorgang im Gange ist. Sobald das Licht erlischt, sind die Kopfhörer vollständig aufgeladen und der Ladevorgang ist abgeschlossen.

Anschließen des Kopfhörers an Ihr Gerät

Koppeln und Verbinden

DE

SCHRITT 1

Schalten Sie die Kopfhörer ein. Bei der ersten Verwendung tritt der Kopfhörer automatisch in den PAIRING-Modus.

Falls dies nicht der Fall ist, setzen Sie die Kopfhörer in den PAIRING-Modus, indem Sie den Schalter  auf "HOLD TO PAIR" schieben und ihn 2 Sekunden lang gedrückt halten, bis die LED rot und blau blinkt.

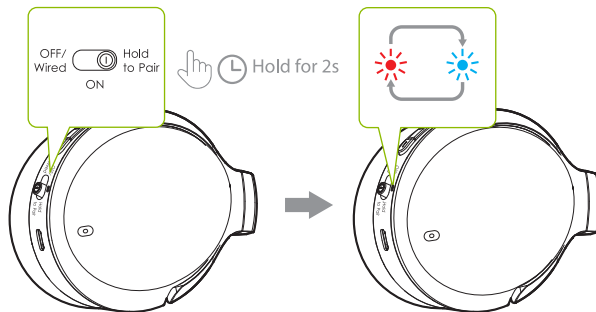

SCHRITT 2

Schalten Sie Bluetooth auf Ihrem Gerät ein und wählen Sie "Avantree Eon" im Bluetooth-Menü aus.

SCHRITT 3

Halten Sie die Kopfhörer in der Nähe Ihres Geräts und warten Sie 5-10 Sekunden oder bis sie verbunden sind. Sobald sie erfolgreich verbunden sind, blinkt die LED-Anzeige der Kopfhörer blau und Sie hören eine Sprachansage "CONNECTED".

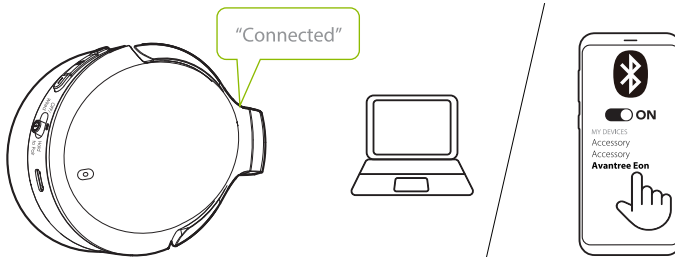

Wenn Sie den Kopfhörer später wieder benutzen, sollte er sich automatisch mit dem innerhalb weniger Sekunden nach dem Einschalten wieder mit dem zuletzt gepaarten Gerät verbinden.

Falls dies nicht der Fall ist, können Sie die erneute Verbindung manuell aktivieren, indem Sie den Schalter  **Hold to Pair** einmal auf "HOLD TO PAIR" setzen oder "Avantree Eon" im Bluetooth-Menü Ihres Geräts auswählen.

Konfigurieren der Audioeinstellungen (nur für PC)

Möglicherweise müssen Sie Ihre Audioeinstellungen konfigurieren, wenn Sie den Eon mit Ihrem PC oder Laptop verwenden.

DE

SCHRITT 1

Öffnen Sie die Audio-Einstellungen Ihres Geräts und stellen Sie "Avantree Eon" als Standard in SOUND AUSGABE / WIEDERGABE ein. Wählen Sie "Avantree Eon" als Standardgerät in EINGABE / MIKROFON aus.

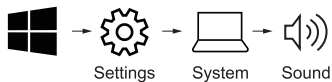

Sound

Output
Choose your output device

Avantree Eon ▾

Input
Choose your input device

Avantree Eon ▾

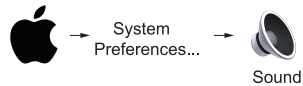

Sound

Output
Select a device for sound output:

Avantree Eon

Input
Select a device for sound input:

Avantree Eon

SCHRITT 2:

Wiederholen Sie die oben genannten Schritte in Ihrer Meetingsoftware (z.B. Teams, Zoom, Skype, etc.)

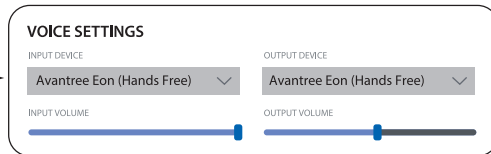
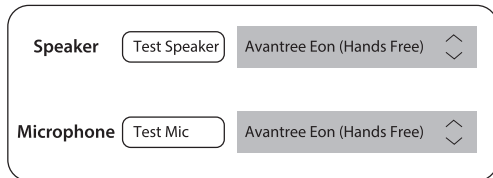
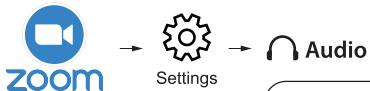
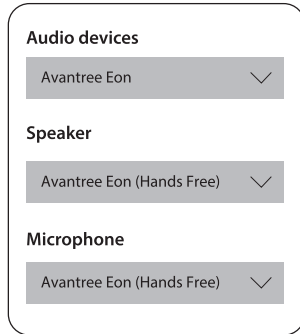
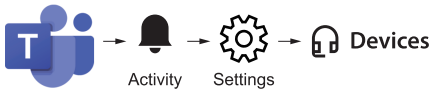

HINWEIS: Unter Windows 11/macOS gibt es keine Option "Freisprecheinrichtung". Wählen Sie stattdessen "Avantree Eon" als Standard aus.

Als kabelgebundene Kopfhörer verwenden

SCHRITT 1

Schieben Sie den Schalter

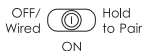

auf "OFF / Wired"

DE

SCHRITT 2

Stecken Sie das AUX-3,5-mm-Audiokabel in die Kopfhörer und Ihr Audioausgabegerät.

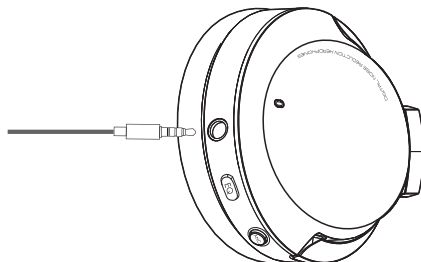

HINWEIS: Im Kabelbetrieb funktionieren die Hörmodi (ANC, Transparenz, normal) und alle anderen integrierten Tasten nicht.

Auswechseln der wiederaufladbaren Batterie

DE

Die wiederaufladbaren Batterien, die sich in beiden Ohrmuscheln der Kopfhörer befinden, können ausgetauscht werden, um die Lebensdauer Ihrer Eon-Kopfhörer zu verlängern. Scannen Sie den unten stehenden QR-Code oder suchen Sie nach "Avantree Eon-Batterie" auf Amazon oder der Avantree-Website, um einen Kauf zu tätigen.

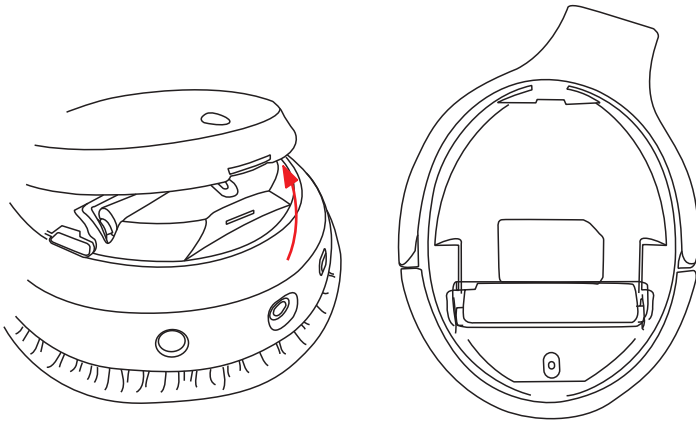

Sie können auch kompatible Batterien mit den folgenden Spezifikationen verwenden: 3,7V Lithium-Ionen-10440 wiederaufladbare Batterie, Kapazität 350mAh.

Besuchen Sie [avantree.com/eon/replace-battery](https://www.avantree.com/eon/replace-battery) für Installationsanweisungen und Details zu empfohlenen Verkäufern.



Technische Daten

Bluetooth-Version	5.0
Unterstützte Audio-Codexs	AAC, SBC
Unterstützte Profile	HSP v1.2, HFP v1.7, AVRCP v1.6 and A2DP v1.3.1
Betriebsreichweite	Up to 50ft / 15m
Treiber	40mm
Impedanz	32Ω
Frequenzbereich	20Hz - 20KHz
Ladezeit	~2.5hrs
Betriebszeit	Up to 45hrs (ANC off)
Standby-Zeit	325hrs (ANC off)
Schalldruckpegel (SPL)	100dB (1kHz / 179MV)
Gesamtklirrfaktor (THD)	<0.5% (1khz)
Produktgröße	191mm x 156mm x 92mm
Gewicht der Kopfhörer	~300g
Innendurchmesser / -tiefe der Ohrpolster	68mm x 47mm / 35mm
Außendurchmesser der Ohrpolster	110mm x 90mm
Stromversorgung	DC5V/500mA~2.0A
Stromanschluss	Type C

HÄUFIG GESTELLTE FRAGEN (FAQ)

DE

Warum schaltet mein Audiosignal mit der Dual Link-Funktion nicht zwischen Telefon und PC um?

Um zwischen Ihrem Telefon und Ihrem PC zu wechseln, unterbrechen Sie zuerst die Audio-Wiedergabe / beenden Sie den Anruf auf dem aktuellen Gerät (entweder mit den Steuerungen auf Ihrem aktiven Gerät oder indem Sie die entsprechende Taste auf den Kopfhörern drücken). Warten Sie 7-10 Sekunden und starten Sie die Audio-Wiedergabe auf dem zweiten Gerät. Der Eon sollte automatisch die Quellen wechseln.

Sie finden eine vollständige Liste häufig gestellter Fragen auf avantree.com/support/eon-b oder kontaktieren Sie uns direkt für zusätzliche Unterstützung.

Kontaktieren Sie uns



Ticket-Support

avantree.com/submit-a-ticket



Support-E-Mail

support@avantree.com



USA / CA

+1800 232 2078 (9am-6pm PST, Mon-Fri)

UK

+44 20 8068 2023 (9am-6pm, GMT, Mon-Sat)

DE

+49 32221097297 (11am-9pm, CET, Mon-Sat)

FR

+ 33 176340312 (11am-9pm, CET, Mon-Sat)

IT

+39 06 9480 3330 (9am-6pm, CET, Mon-Sat)

ES

+ 34 931786261 (9am-6pm, CET, Mon-Sat)

AU

+ 61 2 8310 9897 (11am-7pm, AEST, Mon-Fri)



FAQ

avantree.com/support/eon-b

Sommaire

Contenu de la boîte	33
Introduction	34
Vue d'ensemble produit	34
Fonctions des boutons	35
Indicateurs LED	36
Recharge du casque	37
Connexion du casque à votre équipement.....	38
Appairage & Connexion	38
Réglage des paramètres audio (PC)	40
Usage du casque en filaire	42
Remplacer la batterie	43
Spécifications	44
FAQ.....	45
Comment nous contacter	46

Contenu de la boîte

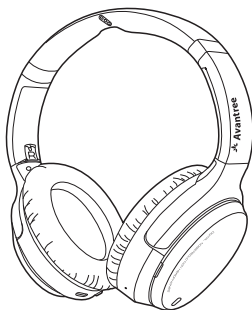

Casque audio Eon B

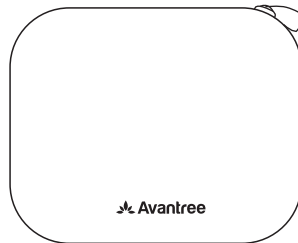

Sacoche de transport

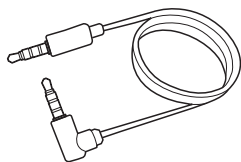

Câble audio AUX 3.5mm

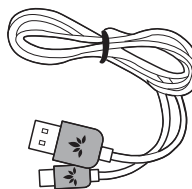

Câble d'alimentation
de Type C

FR



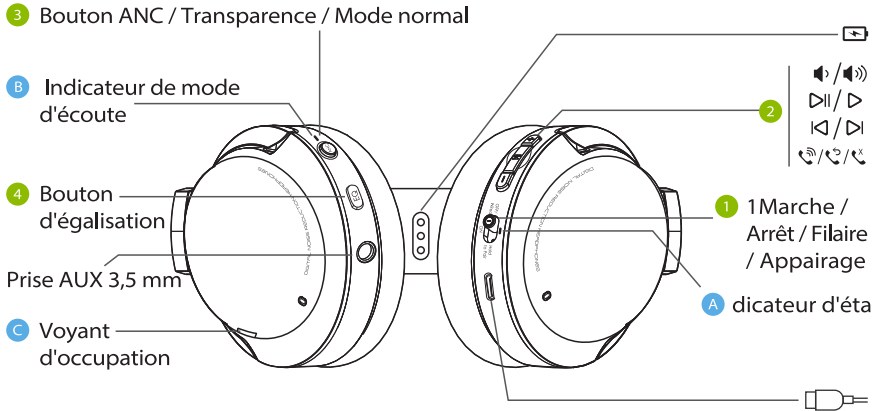

Introduction

Vue d'ensemble produit

FR

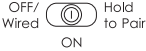

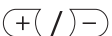
Button Functions

No.	Bouton	Fonctions
1		Positionner sur "ON / OFF" pour allumer ou éteindre le casque
		Positionner sur "WIRED" pour un usage filaire du casque
		Positionner 2 secondes sur "HOLD TO PAIR" pour passer le casque en appairage
2		Appuyer 1 fois pour lecture / pause
		Appuyer 1x pour prends / terminer un appel
		Appuyer et maintenir 2s pour rejeter un appel
		Appuyer 2x pour recomposer un appel
		Appuyer 1x pour augmenter / baisser le volume
		Appuyer et maintenir 2s pour passer / rejouer une piste
Appuyer et maintenir 5s pour effacer l'historique d'appairage		
3		Appuyez 1x pour basculer entre les modes Annulation active du bruit / Transparence (environnement audible) / Normal.
4		Appuyez 1x pour basculer entre les modes équilibré et basses accentuées

LED Indicators

FR

Nb.	Indicateurs & Vocalises	Statut
A	Rouge fixe	En charge
	Rouge clignotant	Batterie faible
	Bleu clignotant, vocalise "BATTERY HIGH / MEDIUM / LOW"	Mise en marche
	Rouge fixe (1s) puis extinction, vocalise "GOODBYE"	Arrêt
	Rouge & bleu alterné, vocalise "PAIRING"	Appairage
	Bleu clignotant toutes les 5s, vocalise "CONNECTED"	Connecté
	Bleu clignotant toutes les 2s, vocalise "DISCONNECTED"	Déconnecté
	Rose durant 5s, puis rouge & bleu alterné	Historique d'appairage effacé
B	Vert fixe, vocalise "NOISE CANCELING"	Mode ANC actif (réduction de bruit environnant)
	Vert clignotant toutes les 5s, vocalise "TRANSPARENCY"	Mode transparence (bruit environnant augmenté)
	LED éteinte, vocalise "NORMAL"	Mode normal
C	Rouge fixe	En appel

Recharge du casque

Une vocalise "BATTERY LOW" et une LED clignotante **A** indique une batterie faible. Pour la recharge et comme source d'alimentation, vous pouvez utiliser soit un adaptateur USB 5V/500mA-2A (ex. chargeur de téléphone ou similaire) ou un port USB PC.

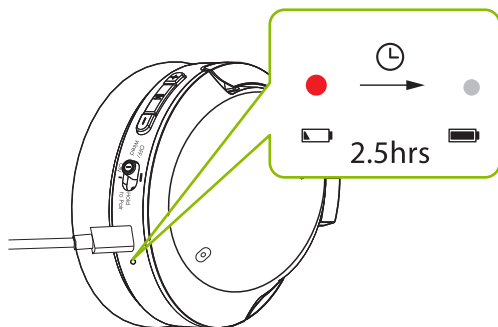

Un voyant rouge fixe indique que la charge est en cours. Une fois la lumière éteinte, vos écouteurs seront rechargés.

Connexion du casque à votre appareil

Appairage & Connexion

FR

ETAPE 1

Allumez les écouteurs. Lors de la première utilisation, le casque entrera automatiquement en APPAIRAGE.

Sinon, maintenez 2s le bouton  sur "HOLD TO PAIR" jusqu'à ce que la LED clignote en rouge et bleu.^{ON}

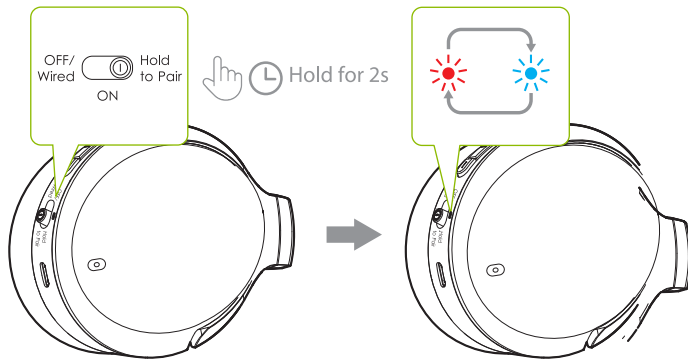



ETAPE 2

Activez le Bluetooth de votre appareil et sélectionnez "Avantree Eon" dans le menu Bluetooth.

ETAPE 3

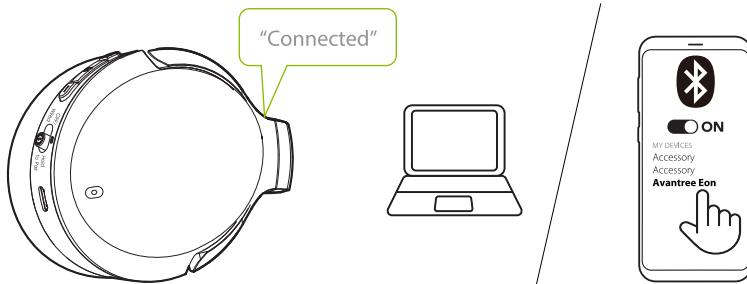
Gardez les écouteurs près de votre appareil et attendez 5 à 10 secondes ou jusqu'à ce qu'ils se connectent. Une fois connectés avec succès, le voyant LED du casque clignote en bleu et vous entendrez un indicateur vocal "CONNECTED".



Pour une utilisation ultérieure, votre casque devrait se reconnecter automatiquement au appareil couplé après quelques secondes et sa mise sous tension. Si non, vous pouvez lancer manuellement la reconnexion en faisant glisser le bouton  sur "HOLD TO PAIR" une fois, ou en sélectionnant "Avantree Eon" dans le menu Bluetooth de votre appareil.

OFF/Wired  Hold to Pair ON

Configuration des paramètres audio (sur PC)

Vous devrez peut-être configurer vos paramètres audio lorsque vous utilisez l'Eon avec votre PC ou votre ordinateur portable.

ETAPE 1

Accédez aux paramètres audio et définissez "Avantree Eon" par défaut dans SORTIE SON / LECTURE (ou similaire). Réglez "Avantree Eon" comme valeur par défaut dans ENTREE / MICRO (ou similaire).

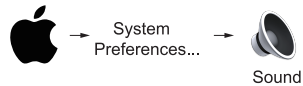
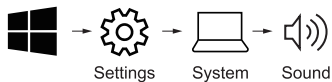

Sound

Output
Choose your output device

Avantree Eon ▾

Input
Choose your input device

Avantree Eon ▾

Sound

Output
Select a device for sound output:

Avantree Eon

Input
Select a device for sound input:

Avantree Eon

ETAPE 2:

Répétez les étapes ci-dessus dans votre logiciel de réunion (ex. Teams, Zoom, Skype, etc.)

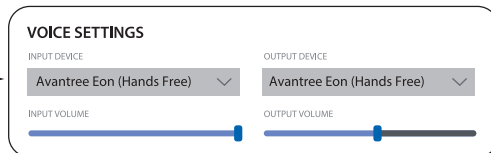
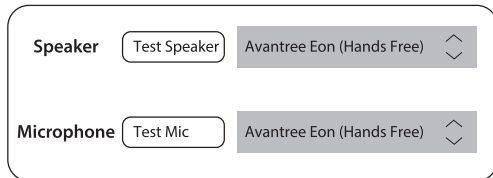
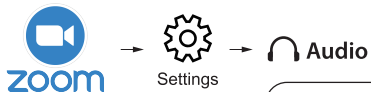
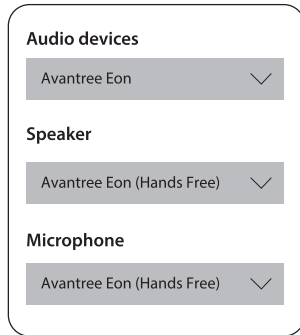
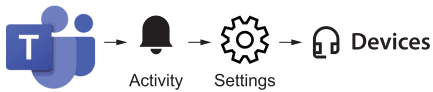

NOTE: Sur Windows 11/ macOS, l'option "Hands Free" est absente. Sélectionnez "Avantree Eon" par défaut.

Utiliser le casque en filaire

ETAPE 1

Glissez le bouton  sur "OFF / Wired."
 OFF/Wired ON Hold to Pair

ETAPE 2

Branchez le câble audio AUX 3,5 mm dans les écouteurs et votre périphérique de sortie audio.

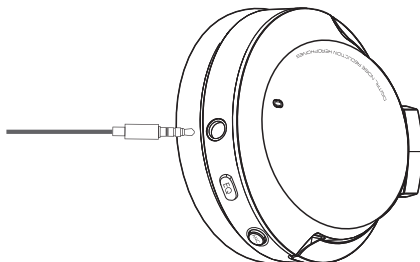

NOTE: En connexion filaire, les modes ANC, transparence, normal et autres boutons intégrés ne fonctionnent pas.

Remplacer la batterie

L'EON dispose de batteries rechargeables situées dans les deux écouteurs. Elles peuvent être remplacées pour prolonger la durée de vie de votre casque audio. Pour en acheter, scannez le code QR ci-dessous ou recherchez "Batterie Avantree Eon" sur Amazon (ou sur notre site web www.avantree.com).

FR

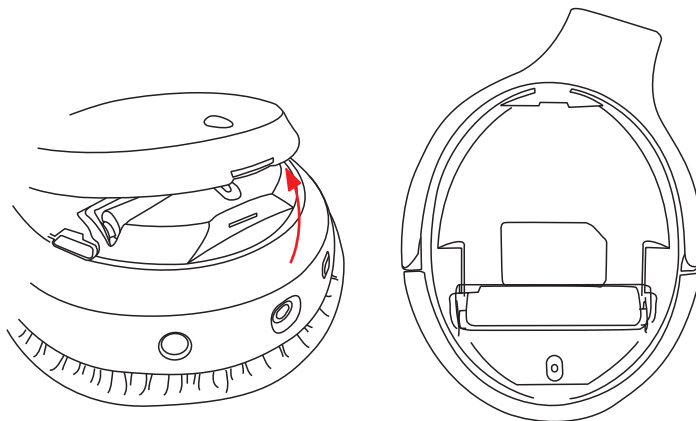

Vous pouvez également utiliser des batteries compatibles avec les spécifications suivantes : batterie rechargeable 3,7 V lithium-ion 10440, capacité 350 mAh.

Visitez notre site avantree.com/eon/replace-battery pour des instructions d'installation et plus de détails sur les vendeurs recommandés.



Spécifications

FR

Version Bluetooth	5.0
Codecs audio supportés	AAC, SBC
Profils supportés	HSP v1.2, HFP v1.7, AVRCP v1.6 and A2DP v1.3.1
Portée de fonctionnement	Jusqu'à 15m
Diamètre haut-parleurs	40mm
Impédance	32Ω
Réponse en fréquence	20Hz - 20KHz
Temps de recharge	~2h30
Autonomie	Jusqu'à 45h (ANC éteint)
Veille	325h (ANC éteinte)
Pression acoustique (SPL)	100dB (1kHz / 179MV)
Distorsion harmonique totale (THD)	<0.5% (1kHz)
Dimensions produit	191mm x 156mm x 92mm
Poids du casque	~300g
Diamètre intérieur / profondeur des coussinets	68mm x 47mm / 35mm
Diamètre extérieur des coussinets	110mm x 90mm
Alimentation de charge	DC5V/500mA~2.0A
Prise de charge	Type C

FAQ

Pourquoi mon audio ne bascule-t-il pas entre mon téléphone et mon PC avec la fonction de double liaison?

Pour basculer entre votre téléphone et votre PC, mettez d'abord en pause l'audio ou mettez fin à votre appel sur l'appareil en cours (soit en utilisant les commandes de votre appareil actif, soit en appuyant sur le bouton correspondant sur le casque).

Après 7 à 10 secondes, lancez l'audio sur le deuxième appareil. L'Eon devrait changer de source automatiquement.

Une liste complète des FAQ est consultable en suivant ce lien avantree.com/support/eon-b. Pour une assistance supplémentaire, contactez-nous directement via les liens ci-dessous.

Comment nous contacter



Support en ligne

avantree.com/submit-a-ticket



Support via email

support@avantree.com



USA / CA

+1800 232 2078 (9am-6pm PST, Mon-Fri)

UK

+44 20 8068 2023 (9am-6pm, GMT, Mon-Sat)

DE

+49 32221097297 (11am-9pm, CET, Mon-Sat)

FR

+ 33 176340312 (11am-9pm, CET, Mon-Sat)

IT

+39 06 9480 3330 (9am-6pm, CET, Mon-Sat)

ES

+ 34 931786261 (9am-6pm, CET, Mon-Sat)

AU

+ 61 2 8310 9897 (11am-7pm, AEST, Mon-Fri)



FAQ

avantree.com/support/eon-b

Contenuti

Contenuto della Confezione	48
Introduzione al Prodotto	49
Panoramica del prodotto	49
Funzione dei Tasti	50
Indicatori LED	51
Ricaricare le Cuffie	52
Collegare le Cuffie ai Dispositivi	53
Pairing & Connessione	53
Configurazione Impostazioni Audio (solo per PC)	55
Utilizzo come Cuffie Cablate	57
Sostituire la Batteria Ricaricabile	58
Specifiche	59
FAQ	60
Contatti	61



Contenuto della confezione

IT

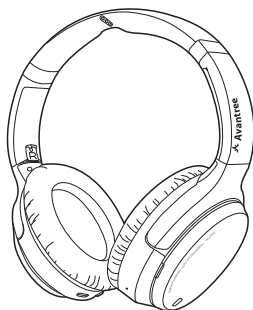

Cuffie Eon B

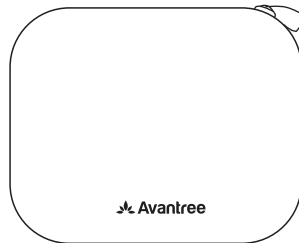

Custodia

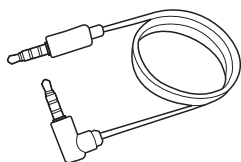

Cavo audio AUX da 3,5 mm

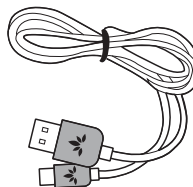



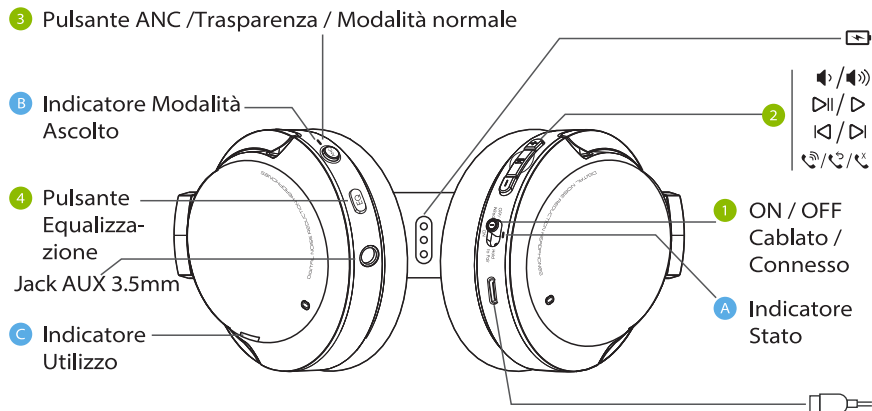

Cavo di alimentazione
di tipo C

Introduzione al Prodotto

Panoramica del Prodotto



Funzione dei Tasti

No.	Tasto	Funzione
1	 <p>OFF/Wired ON Hold to Pair</p>	Passare alla posizione "ON/OFF" per accendere / spegnere le cuffie
		Passare alla posizione "WIRED" per utilizzare come cuffie cablate
		Passare alla posizione "HOLD TO PAIR" e tenere premuto per 2 secondi per accedere alla modalità di associazione
2		Premere una volta per riprodurre / mettere in pausa
		Premere una volta per accettare / terminare la chiamata
		Tenere premuto per 2 secondi per rifiutare la chiamata
		Premere due volte per ricomporre l'ultimo numero
		Premere una volta per aumentare / diminuire il volume
		Tenere premuto per 2 secondi per saltare / riprodurre la traccia
Tenere premuti entrambi i pulsanti per 5 secondi per cancellare la cronologia degli accoppiamenti		
3		Premi una volta per alternare le modalità Cancellazione attiva del rumore / Trasparenza (ascolta l'ambiente circostante) / Normale.
4		Premere una volta per passare dalla modalità bilanciata a quella con potenziamento dei bassi

Indicatori LED

No.	Indicatore e Messaggio Vocale	Stato
A	Rosso fisso	Carica
	Rosso lampeggiante	Batteria scarica
	Blu lampeggiante, indicatore vocale "BATTERIA ALTA / MEDIA / BASSA".	Accensione
	Rosso fisso per 1 secondo poi spento, indicatore vocale "GOODBYE".	Spegnimento
	Rosso e Blu che lampeggiano alternati, indicazione vocale "PAIRING".	Pairing
	Blu lampeggiante ogni 5 secondi, indicatore vocale "CONNESSO".	Connessione
	Blu lampeggiante ogni 2 secondi, indicatore vocale "DISCONNESSO".	Disconnessione
	Rosa fisso per 5 secondi, quindi lampeggi rossi e blu alternati	Storico connessioni cancellato
B	Verde fisso, indicatore vocale "NOISE CANCELING".	Modalità di Cancellazione Attiva del Rumore (ANC).
	Verde lampeggiante ogni 5 secondi, indicazione vocale "TRANSPARENCY".	Modalità Trasparenza
	LED spento, indicatore vocale "NORMALE".	Modalità normale
C	Rosso fisso	In chimata



Ricarica

Un messaggio vocale "BATTERIA SCARICA" e una luce rossa lampeggiante A indicheranno che la batteria è scarica. Per caricare, è possibile utilizzare un adattatore USB da 5V/500 mA-2 A (il caricatore del telefono o simili dovrebbe funzionare) o la porta USB del PC come fonte di alimentazione.

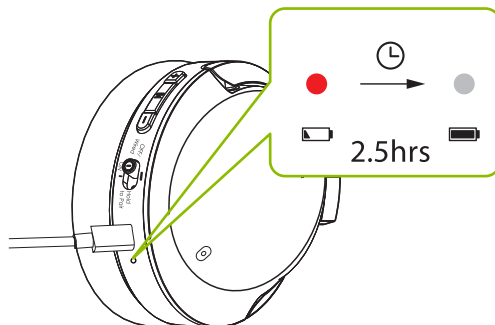

Una luce rossa fissa indica che la ricarica è in corso; una volta che la luce si spegne, le tue cuffie saranno completamente cariche.

Collegamento delle Cuffie al Dispositivo

Pairing & Connessione

Passo 1

Accendi le cuffie. Al primo utilizzo, le cuffie entreranno automaticamente in modalità PAIRING.

In caso contrario, metti le cuffie in modalità PAIRING facendo scorrere il tasto

 nella posizione "HOLD TO PAIR" per 2 secondi fino a quando il LED lampeggia in rosso e blu.

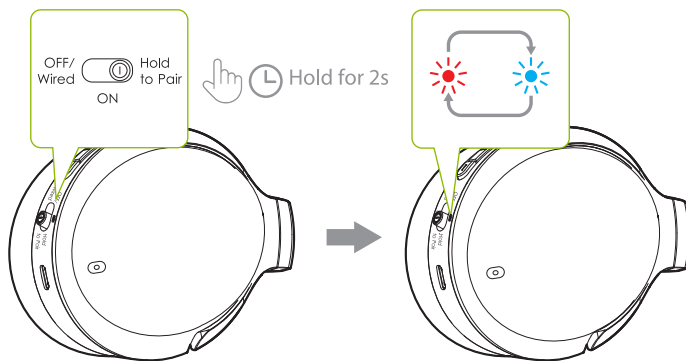

Passo 2

Attiva il Bluetooth del tuo dispositivo e seleziona "Avantree Eon" nel menu Bluetooth.

Passo 3

Tieni le cuffie vicino al tuo dispositivo e attendi 5-10 secondi o finché non si connettono. Una volta collegati correttamente, l'indicatore LED delle cuffie lampeggerà in blu e sentirai un indicatore vocale "CONNESSO".

IT

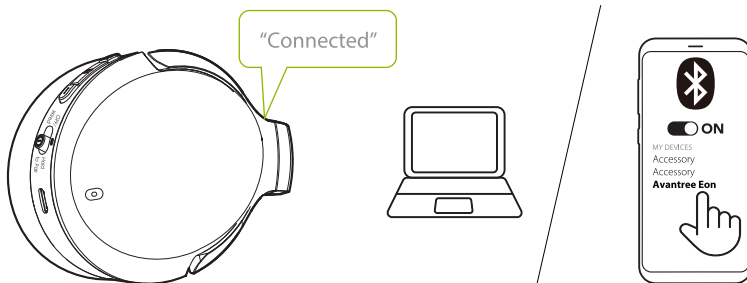

Per un utilizzo successivo, le cuffie dovrebbero riconnettersi automaticamente all'ultimo dispositivo associato entro pochi secondi dall'accensione. In caso contrario, è possibile attivare manualmente la riconnessione facendo scorrere il tasto  sulla posizione "HOLD TO PAIR" una volta, o selezionando "Avantree Eon" nel menu Bluetooth del tuo dispositivo.

Configurazione delle Impostazioni Audio (solo per PC)

Potrebbe essere necessario configurare le impostazioni audio quando si utilizza Eon con il PC o il laptop.

Passo1

Accedi alle impostazioni audio del tuo dispositivo e imposta "Avantree Eon" come predefinito in USCITA AUDIO / RIPRODUZIONE. Impostare "Avantree Eon" come predefinito in INPUT / MICROPHONE DEVICE.

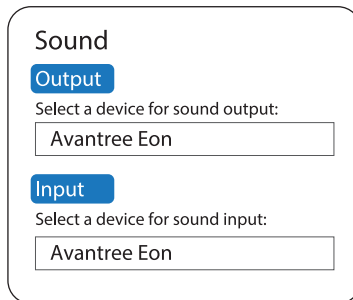
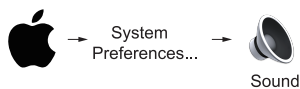
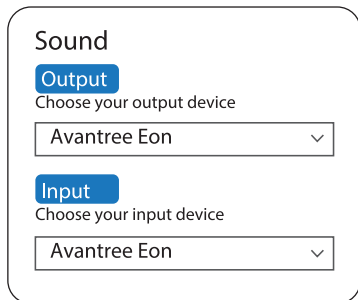
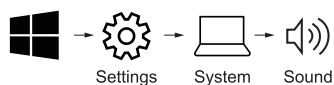

Passo 2:

Ripeti i passaggi precedenti in tuo software per riunioni (ad es. Teams, Zoom, Skype, ecc.)

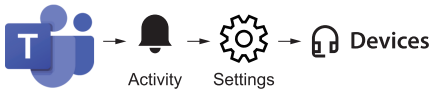

Audio devices

Avantree Eon ▾

Speaker

Avantree Eon (Hands Free) ▾

Microphone

Avantree Eon (Hands Free) ▾

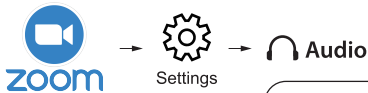

Speaker Avantree Eon (Hands Free) ▾

Microphone Avantree Eon (Hands Free) ▾



VOICE SETTINGS

INPUT DEVICE: Avantree Eon (Hands Free) ▾

OUTPUT DEVICE: Avantree Eon (Hands Free) ▾

INPUT VOLUME:

OUTPUT VOLUME:

NOTA: Su Windows 11 / macOS, non è disponibile l'opzione "Vivavoce"; seleziona invece "Avantree Eon" come predefinito.

Utilizzo come Cuffie Cablate

Passo 1

Muovere il tasto  sulla posizione "OFF / Wired."

Passo 2

Collega il cavo audio AUX da 3,5 mm sia alle cuffie che al dispositivo di uscita audio.

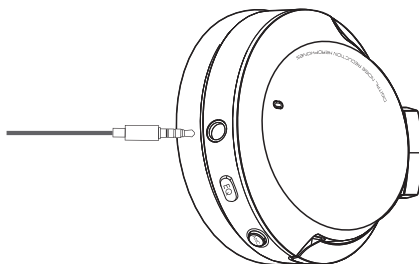

NOTA: In modalità cablata, le modalità di ascolto (ANC, trasparenza, normale) e tutti gli altri pulsanti integrati non funzionano.

Sostituzione della Batteria Ricaricabile

Le batterie ricaricabili, situate in entrambe le cuffie, possono essere sostituite per prolungare la durata della tua Eon. Scansiona il codice QR qui sotto o cerca "Batteria Avantree Eon" su Amazon o sul sito web di Avantree per procedere all'acquisto.

IT

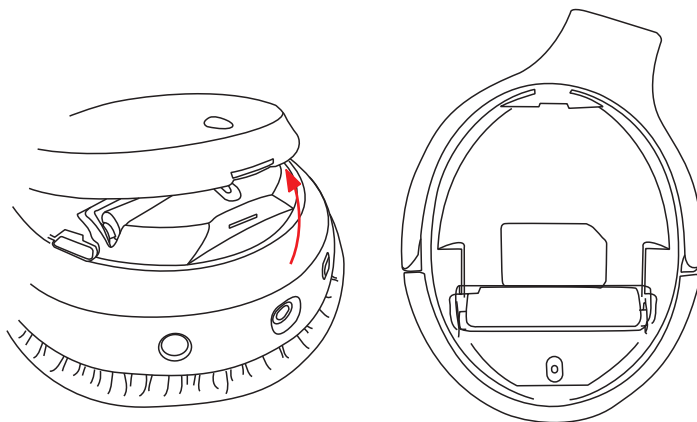

È inoltre possibile utilizzare batterie compatibili con le seguenti specifiche: Batteria ricaricabile 10440 agli ioni di litio da 3,7 V, capacità 350 mAh.

Visita avantree.com/eon/replace-battery per le istruzioni di installazione e i dettagli dei venditori consigliati.



Specifications

Versione Bluetooth	5.0
Codec Audio Supportati	AAC, SBC
Profili Supportati	HSP v1.2, HFP v1.7, AVRCP v1.6 and A2DP v1.3.1
Raggio di Connessione	Up to 50ft / 15m
Drivers	40mm
Impedenza	32Ω
Frequenza di Risposta	20Hz - 20KHz
Tempo di Ricarica	~2.5hrs
Tempo di Operatività	Fino a 45 ore (ANC disattivato)
Tempo di Standby	325 ore (ANC disattivato)
Pressione del Suono (SPL)	100dB (1kHz / 179MV)
Distorsione Armonica (THD)	<0.5% (1kHz)
Dimensioni	191mm x 156mm x 92mm
Peso delle Cuffie	~300g
Diametro Interno delle cuffie	68mm x 47mm / 35mm
Diametro Esterno delle cuffie	110mm x 90mm
Caricatore	DC5V/500mA~2.0A
Porta di Ricarica	Type C

FAQ

Perché il mio audio non passa dal telefono al PC con la funzione dual link?

Per passare dal telefono al PC, prima metti in pausa l'audio/termina la chiamata sul dispositivo corrente (utilizzando i controlli sul dispositivo attivo o premendo il pulsante corrispondente sulle cuffie).

Dopo 7-10 secondi, avviare l'audio sul secondo dispositivo. L'Eon dovrebbe scambiare automaticamente le fonti.

Puoi trovare un elenco completo di domande frequenti su avantree.com/support/eon-b o contattarci direttamente per ulteriore assistenza.

Contattaci



Supporto ticket

avantree.com/submit-a-ticket



Email di supporto

support@avantree.com



USA / CA

+1800 232 2078 (9am-6pm PST, Mon-Fri)

UK

+44 20 8068 2023 (9am-6pm, GMT, Mon-Sat)

DE

+49 32221097297 (11am-9pm, CET, Mon-Sat)

FR

+ 33 176340312 (11am-9pm, CET, Mon-Sat)

IT

+39 06 9480 3330 (9am-6pm, CET, Mon-Sat)

ES

+ 34 931786261 (9am-6pm, CET, Mon-Sat)

AU

+ 61 2 8310 9897 (11am-7pm, AEST, Mon-Fri)



Domande frequenti (FAQ)

avantree.com/support/eon-b

Contenidos

Contenidos de la Caja	63
Introducción del Producto	64
Descripción del producto	64
Función de las Teclas	65
Indicadores LED	66
Recargar los Auriculares	67
Conectar Auriculares a Dispositivos	68
Emparejamiento y Conexión	68
Configuración de Ajustes de Audio (solo para PC)	70
Uso como un Auricular con Cable	72
Reemplazar la Batería Recargable	73
Especificaciones	74
FAQ	75
Contactos	76

Contenido de la Caja

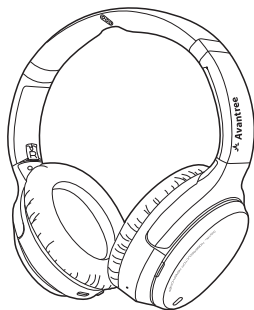

Auriculares Eon B

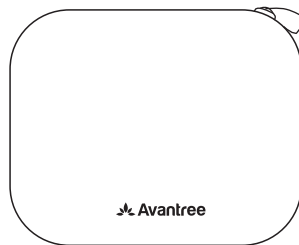

Maletín de transporte

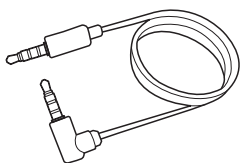

Cable de audio AUX de 3,5 mm

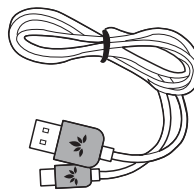

Cable de alimentación tipo C

ES

Introducción del Producto

Descripción del Producto

ES

3 Botón de modo ANC/Transparencia/Normal

B Indicador de modo de audición

4 Botón de Ecualización

Conector AUX de 3,5 mm

C Indicador de Uso





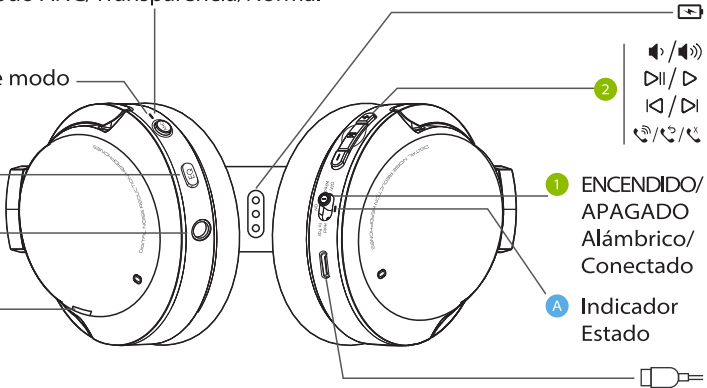

1 ENCENDIDO/APAGADO Alámbrico/Conectado

A Indicador Estado

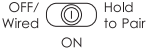

Button Functions

No.	Tecla	Función
1		Cambia a la posición "ON/OFF" para encender/apagar los auriculares.
		Cambie a la posición "WIRED" para usarlo como auricular con cable
		Cambie a la posición "HOLD TO PAIR" y manténgalo presionado durante 2 segundos para ingresar al modo de emparejamiento
2		Presione una vez para reproducir / pausar
		Presione una vez para aceptar / finalizar la llamada
		Mantenga presionado durante 2 segundos para rechazar la llamada
		Presione dos veces para volver a marcar el último número
		Presione una vez para aumentar/disminuir el volumen
		Mantenga presionado durante 2 segundos para saltar/reproducir la canción
	Mantenga presionados ambos botones durante 5 segundos para borrar el historial de emparejamiento	
	Presione una vez para cambiar entre los modos Cancelación activa de ruido/Transparencia (escuche su entorno)/Normal.	
4		Presione una vez para alternar entre los modos equilibrado y de refuerzo de graves

Indicatori LED

No.	Indicador y Mensaje de Voz	Estado
A	Rojo solido	Carga
	Rojo intermitente	Batería baja
	Azul intermitente, indicador de voz "BATERÍA ALTA / MEDIA / BAJA".	Encendido
	Rojo fijo durante 1 segundo y luego apagado, mensaje de voz "GOODBYE".	Apagado
	Rojo y azul parpadeando alternativamente, mensaje de voz "PAIRING".	Emparejamiento
	Parpadeo azul cada 5 segundos, indicador de voz "CONECTADO".	Conexión
	Parpadeo azul cada 2 segundos, indicador de voz "DESCONECTADO".	Desconexión
	Rosa fijo durante 5 segundos, luego se alternan destellos rojos y azules	Historial de conexiones eliminado
B	Verde fijo, indicador de voz "NOISE CANCELING".	Modo de Cancelación Activa de Ruído (ANC).
	Parpadeando en verde cada 5 segundos, mensaje de voz "TRANSPARENCY".	Modo de transparencia
	LED apagado, indicador de voz "NORMAL".	Modo normal
C	Rojo sólido	En llamada

Recargar

Un mensaje de voz "LOW BATTERY" y una luz roja parpadeante indicarán que la batería está baja. Para cargar, puede utilizar un adaptador USB de 5 V/500 mA-2 A (el cargador de teléfono o similar debería funcionar) o un puerto USB de PC como fuente de alimentación.

El LED de la base de carga se volverá blanco durante la carga y se volverá verde cuando se complete la carga.

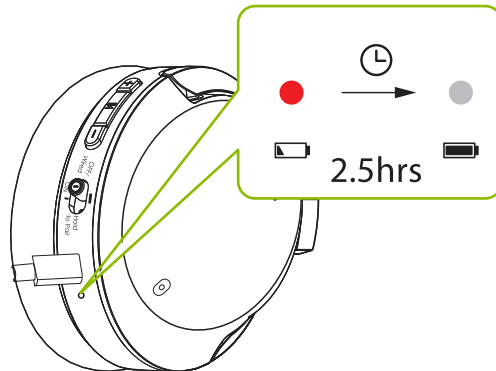

Una luz roja fija indica que la carga está en curso; una vez que la luz se apague, sus auriculares estarán completamente cargados.

Conexión de los Auriculares al Dispositivo

Emparejamiento y conexión

PASO 1

Enciende los auriculares. Al usarlos por primera vez, los auriculares entrarán automáticamente en modo PAIRING. Si no, pon los auriculares en modo PAIRING

deslizando la tecla  en la posición "HOLD TO PAIR" durante 2 segundos hasta que el LED parpadee en rojo y azul.

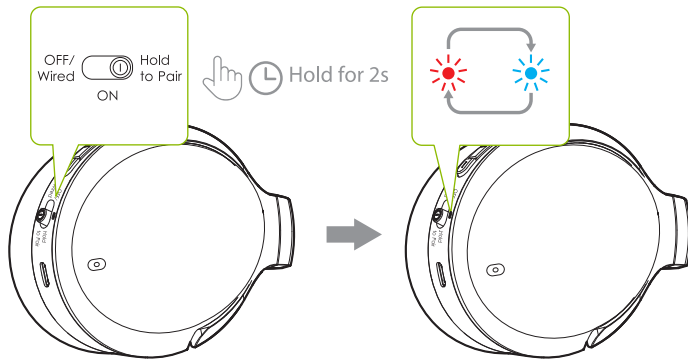



PASO 2

Encienda el Bluetooth de su dispositivo y seleccione "Avantree Eon" en el menú de Bluetooth.

PASO 3

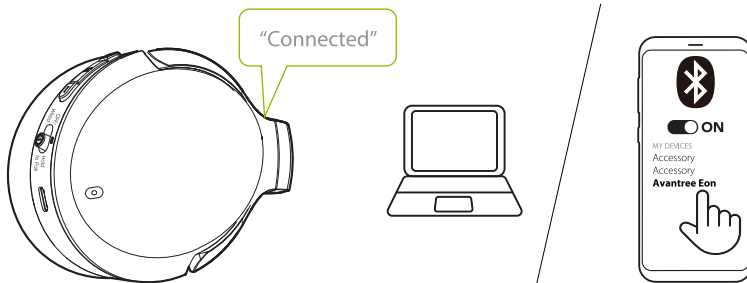
Sostenga los auriculares cerca de su dispositivo y espere de 5 a 10 segundos o hasta que se conecten. Una vez conectado correctamente, el indicador LED de los auriculares parpadeará en azul y escuchará el mensaje de voz "CONECTADO".



Para un uso posterior, los auriculares deberían volver a conectarse automáticamente al último dispositivo emparejado unos segundos después de encenderlos. De lo contrario, puede activar manualmente la reconexión deslizando la tecla  en la posición "HOLD TO PAIR" una vez, o seleccionando "Avantree Eon" en el menú Bluetooth de su dispositivo.

Configuración de ajustes de audio (solo para PC)

Es posible que deba configurar sus ajustes de audio cuando utilice el Eon con su PC o computadora portátil.

PASO 1

Acceda a la configuración de audio de su dispositivo y configure "Avantree Eon" como predeterminado en SALIDA DE AUDIO / REPRODUCCIÓN. Configure "Avantree Eon" como predeterminado en ENTRADA / DISPOSITIVO DE MICRÓFONO.

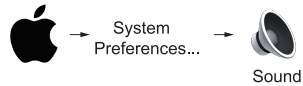
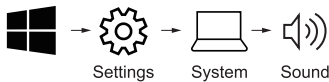

Sound

Output
Choose your output device

Avantree Eon
▼

Input
Choose your input device

Avantree Eon
▼

Sound

Output
Select a device for sound output:

Avantree Eon
▼

Input
Select a device for sound input:

Avantree Eon
▼

PASO 2:

Repita los pasos anteriores en su software de reuniones (por ejemplo, Teams, Zoom, Skype, etc.)

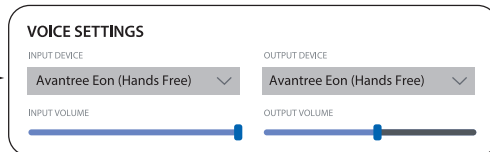
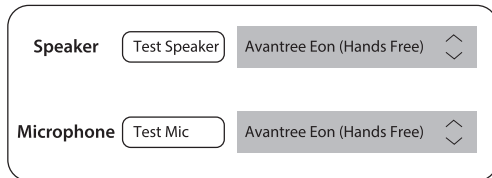
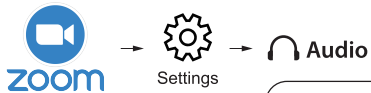
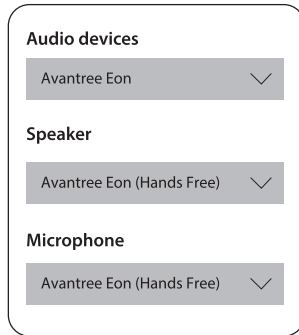
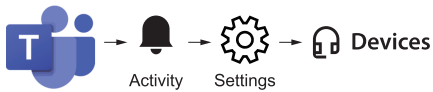

NOTA: En Windows 11 / macOS, la opción "Altavoz" no está disponible; seleccione "Avantree Eon" como el valor predeterminado en su lugar.

Uso como un Auricular con Cable

PASO 1

Mueva la llave  a la posición "OFF/WIRED".

PASO 2

Conecte el cable de audio AUX de 3,5 mm tanto a los auriculares como al dispositivo de salida de audio.

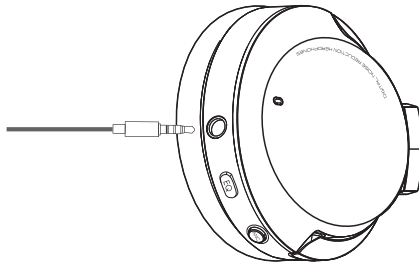

NOTA: En el modo con cable, los modos de audición (ANC, transparencia, normal) y todos los demás botones integrados no funcionan.

Reemplazo de la Batería Recargable

Las baterías recargables, ubicadas en ambos auriculares, se pueden reemplazar para prolongar la vida útil de su Eon. Escanee el código QR a continuación o busque "Avantree Eon Battery" en Amazon o en el sitio web de Avantree para comprar.

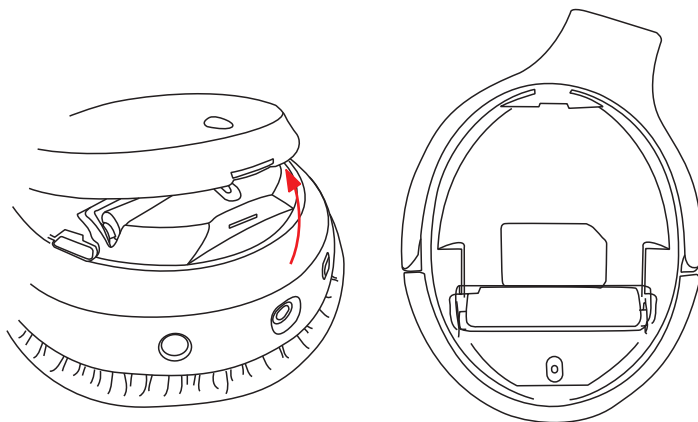

ES

También puede utilizar baterías compatibles con las siguientes especificaciones: batería recargable de iones de litio 3,7 V 10440, capacidad de 350 mAh.

Visite avantree.com/eon/replace-battery para obtener instrucciones de instalación y detalles de los vendedores recomendados.



Specifiche

Versión Bluetooth	5.0
Códecs de Audio compatibles	AAC, SBC
Perfiles Compatibles	HSP v1.2, HFP v1.7, AVRCP v1.6 and A2DP v1.3.1
Radio de Conexión	Hasta a 15m
Drivers	40mm
Impedancia	32Ω
Frecuencia de Respuesta	20Hz - 20KHz
Tiempo de recarga	~2.5hrs
Tiempo de funcionamiento	Hasta 45 horas (ANC desactivado)
Tiempo en Standby	325 horas (ANC desactivado)
Presión de sonido (SPL)	100dB (1kHz / 179MV)
Distorsión armónica (THD)	<0.5% (1kHz)
Dimensiones	191mm x 156mm x 92mm
Peso de los Auriculares	~300g
Diámetro interno de los Auriculares	68mm x 47mm / 35mm
Diámetro exterior de los Auriculares	110mm x 90mm
Cargador	DC5V/500mA~2.0A
Puerto de Carga	Type C

FAQ

Por qué mi audio no pasa del teléfono a la PC con la función de doble enlace?

Para cambiar entre el teléfono y la PC, primero pause/finalice la llamada en el dispositivo actual (ya sea usando los controles en el dispositivo activo o presionando el botón correspondiente en el auricular).

Después de 7 a 10 segundos, inicie el audio en el segundo dispositivo. El Eon debería intercambiar fuentes automáticamente.

Puede encontrar una lista completa de preguntas frecuentes en avantree.com/support/eon-b o contáctenos directamente para obtener más ayuda.

Contattaci

 **Soporte por ticket** avantree.com/submit-a-ticket

 **Soporte por correo electrónico** support@avantree.com

 **USA / CA** +1800 232 2078 (9am-6pm PST, Mon-Fri)
UK +44 20 8068 2023 (9am-6pm, GMT, Mon-Sat)
DE +49 32221097297 (11am-9pm, CET, Mon-Sat)
FR + 33 176340312 (11am-9pm, CET, Mon-Sat)
IT +39 06 9480 3330 (9am-6pm, CET, Mon-Sat)
ES + 34 931786261 (9am-6pm, CET, Mon-Sat)
AU + 61 2 8310 9897 (11am-7pm, AEST, Mon-Fri)

 **Preguntas frecuentes** avantree.com/support/eon-b

目次

箱の内容	78
製品概要	79
各部名称	79
ボタンの操作	80
LEDインジケーター	81
ヘッドホンを充電する	82
ヘッドホンをデバイスに接続する	83
ペアリングと接続	84
オーディオの設定を行う（PCのみ）	85
有線ヘッドホンとして使用する	87
リチャージャブルバッテリーを交換する	88
製品仕様	89
FAQ よくあるご質問（FAQ）	90
お問い合わせ	91

箱の内容

JP

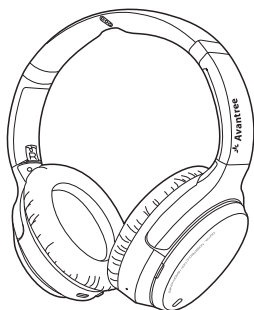

Eon B ヘッドホン

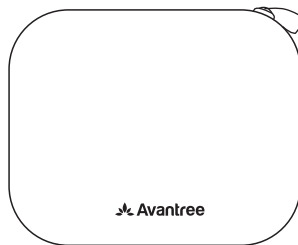

キャリングケース

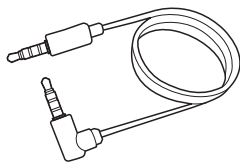

3.5mm AUXオーディオケーブル

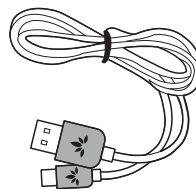

Type-C電源ケーブル

製品概要

各部名称

③ ANC / トランスペアレンシー / 通常モードボタン

② リスニングモード
インジケータ

④ EQモード
ボタン

Conector AUX
de 3,5 mm



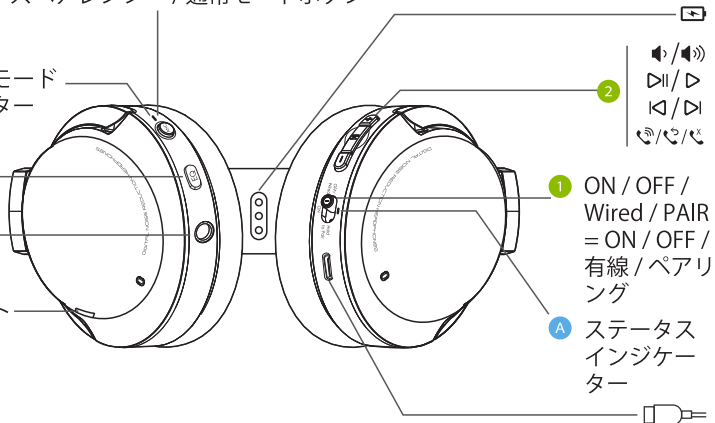

① ビジーライト

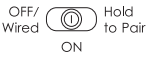

① ON / OFF /
Wired / PAIR
= ON / OFF /
有線 / ペアリン
グ

② ステータス
インジケー
ター

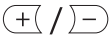
df

No.	ボタン	操作方法
1		スイッチを「ON / OFF」の位置に合わせると、ヘッドホンがオン/オフになります
		有線ヘッドホンとして使用する場合は、スイッチを「Wired」の位置に合わせます
		スイッチを「Hold to Pair」の位置に合わせて2秒間長押しすると、ペアリングモードになります
2		1回押すと、再生 / 一時停止します
		1回押すと、通話を受信 / 終了します
		2秒長押しすると、通話を拒否します
		2回押すと、最後にかけた番号に再ダイヤルします
		1回押すと、音量が大きく / 小さくなります
		2秒間長押しすると、曲をスキップ / リプレイします
両ボタンを5秒間長押しすると、ペアリング履歴が消去されます		
3		1回押すと、アクティブノイズキャンセリング / トランスペアレンシー (周囲の音が聞こえる) / 通常モードに切り替わります
4		1回押すと、バランスモードとバスブーストモードに切り替わります

LEDインジケーター

No.	インジケーターと音声プロンプト	ステータス
A	赤色点灯	充電中
	赤色点滅	バッテリー残量低下
	青色点滅、「BATTERY HIGH / MEDIUM / LOW」音声ガイダンス	電源オン
	赤色で1秒間点灯後消灯、「GOODBYE」音声ガイダンス	電源オフ
	赤と青色の交互点滅、「PAIRING」音声ガイダンス	ペアリング中
	5秒ごとに青色点滅、「CONNECTED」音声ガイダンス	接続済み
	2秒ごとに青色点滅、「DISCONNECTED」音声ガイダンス	接続解除済み
	ピンク色で5秒間点灯後、赤と青色の交互点滅	ペアリング履歴消去中
B	緑色点灯、「NOISE CANCELING」音声ガイダンス	アクティブノイズキャンセリング(ANC)モード
	5秒ごとに緑色点滅、「TRANSPARENCY」音声ガイダンス	トランスペアレンシーモード
	LED消灯、「NORMAL」音声ガイダンス	通常モード
C	赤色点灯	通話中

ヘッドホンを充電する

「BATTERY LOW」の音声ガイダンスと **A** の赤色点滅で、バッテリー残量が少ないことを示します。充電には、5V/500mA-2A USBアダプター（携帯電話の充電器などが使用可能）またはPCのUSBポートを電源として使用することができます。

JP

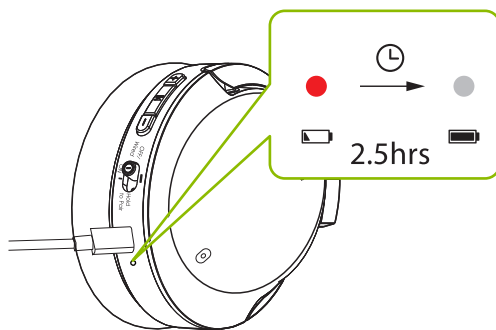

赤色の点灯は充電中であることを示し、消灯するとヘッドホンのバッテリーが完全に充電されたことを示します。

ヘッドホンをデバイスに接続する

ペアリングと接続

ステップ 1

ヘッドホンの電源をオンにします。初めて使用する場合、ヘッドホンは自動的にペアリングモードになります。

ペアリングされない場合は、^{OFF/Wired}  ^{Hold to Pair} スイッチを「Hold to Pair」にスライドさせて、LEDが赤と青に点滅するまで2秒間押し続けてヘッドホンをペアリングモードにします。

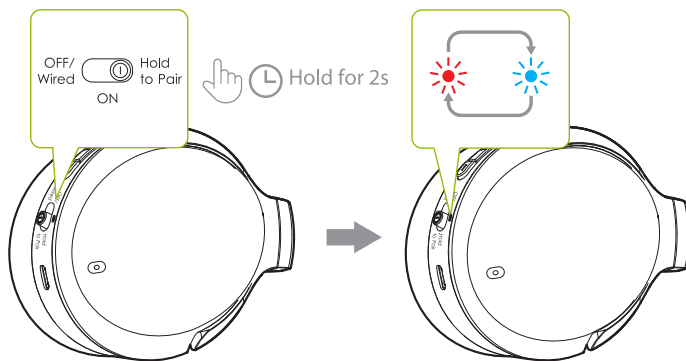



ステップ 2

デバイスのBluetoothをオンにし、Bluetoothメニューで「Avantree Eon」を選択します。

ステップ 3

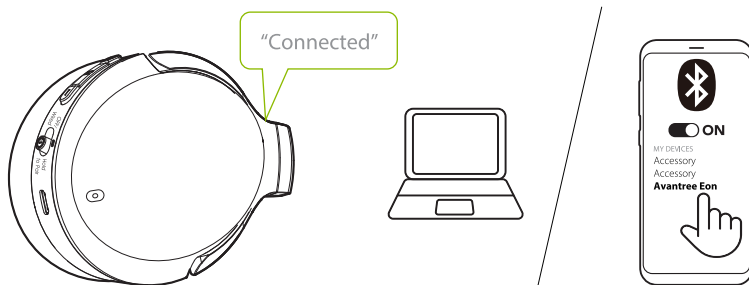
ヘッドホンをデバイスに近づけ、5～10秒または接続するまで待ちます。正常に接続されると、ヘッドホンのLEDインジケーターが青く点滅し、「CONNECTED」という音声ガイダンスが聞こえます。



初回以降は、ヘッドホンの電源を入れてから数秒以内に、最後にペアリングしたデバイスに自動的に再接続します。接続されない場合は、
OFF/Wired  Hold to Pair
ON

スイッチを1回「Hold to Pair」にスライドさせるか、デバイスのBluetoothメニューで「Avantree Eon」を選択することで、手動で再接続を有効にすることができます。

オーディオの設定を行う（PCのみ）

PCまたはラップトップで Eon を使用する場合、オーディオ設定を構成する必要がある場合があります。

ステップ 1

デバイスのオーディオ設定にアクセスし、「音声出力 / 再生」で「Avantree Eon」をデフォルトに設定します。入力 / マイクで「Avantree Eon」をデフォルトに設定します。

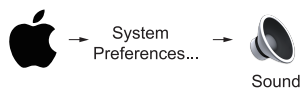
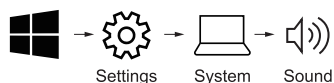

Sound

Output
Choose your output device

Avantree Eon ▾

Input
Choose your input device

Avantree Eon ▾

Sound

Output
Select a device for sound output:

Avantree Eon

Input
Select a device for sound input:

Avantree Eon

ステップ 2:

お使いのビデオ会議ソフトウェア（Teams、Zoom、Skypeなど）で上記の手順を繰り返します。

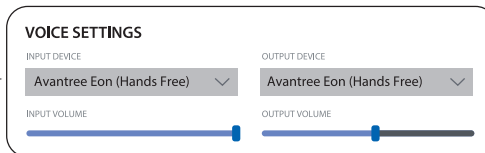
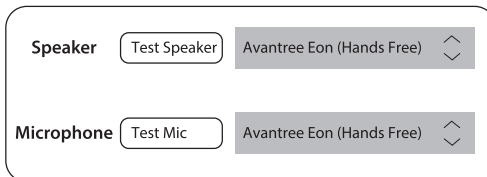
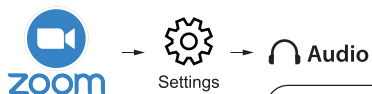
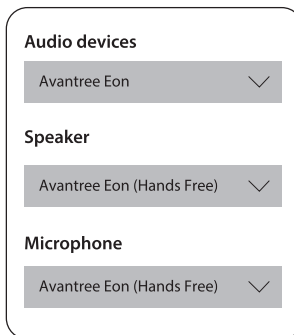
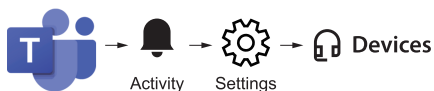

注意: Windows 11/macOSでは、「ハンズフリー」オプションはありません。代わりに「Avantree Eon」をデフォルトとして選択してください。

有線ヘッドホンとして使用する

ステップ 1

OFF/Wired  Hold to Pair スイッチを「OFF / Wired」にスライドさせます。

ON

ステップ 2

3.5mm AUXオーディオケーブルを、ヘッドホンと音声出力デバイスの両方に差し込みます。

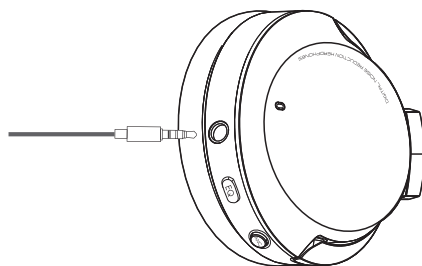

注意: 有線モードでは、リスニングモード (ANC、トランスペアレンシー、通常) および他のすべての内蔵ボタンは機能しません。

リチャージャブルバッテリーを交換する

ヘッドホン両耳にある充電電池を交換することで、Eonの寿命を延ばすことができます。購入するには、下記のQRコードを読み取るか、AmazonやAvantreeのサイトで「Avantree Eon battery」と検索してください。

JP

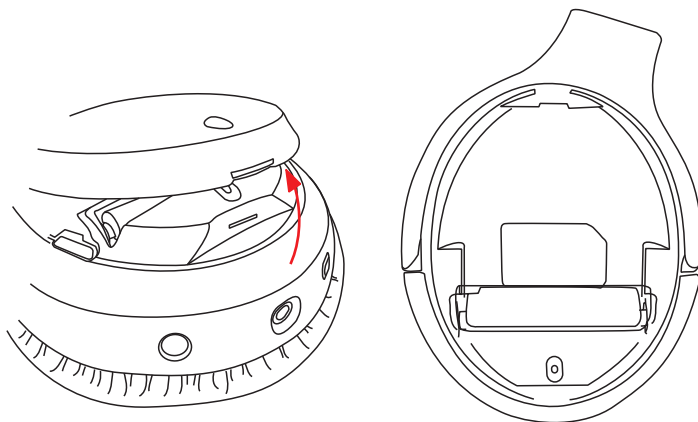

また、以下の仕様の互換バッテリーを使用することも可能です。

リチウムイオン10440充電電池 3.7V 容量: 350mAh

設置方法と推奨販売店の詳細については、avantree.com/eon/replace-batteryをご覧ください。



製品仕様

Bluetoothのバージョン	5.0
対応音声コーデック	AAC, SBC
対応プロファイル	HSP v1.2, HFP v1.7, AVRCP v1.6 and A2DP v1.3.1
動作範囲	最大50ft / 15m
ドライバー	40mm
インピーダンス	32Ω
周波数特性	20Hz - 20KHz
充電時間	約2.5時間
駆動時間	最大45時間 (ANCオフ時)
待機時間	325時間 (ANCオフ時)
音圧レベル (SPL)	100dB (1kHz / 179MV)
全高調波歪率 (THD)	<0.5% (1kHz)
製品サイズ	191mm x 156mm x 92mm
ヘッドホン重量	~300g
イヤークッション内径/深さ	68mm x 47mm / 35mm
イヤークッション外径	110mm x 90mm
電源	DC5V/500mA~2.0A
電源ポート	Type C

FAQ よくあるご質問（FAQ）

デュアルリンク機能で、スマホとPCの間で音声切り替わらないのはなぜですか？

携帯電話とPCを切り替えるには、まず現在のデバイスで音声を一時停止し、通話を終了します（有効なデバイスのコントロールを使用するか、ヘッドフォンの対応するボタンを押します）。

7～10秒後、2台目のデバイスで音声を開始します。Eonは自動的にソースを切り替えるはずですが。

JP

FAQの一覧はavantree.com/support/eon-bでご覧いただけます。また、追加のサポートについては直接お問い合わせください。

お問い合わせ

 サポートチケット avantree.com/submit-a-ticket

 サポートメール support@avantree.com

 **USA / CA** +1800 232 2078 (9am-6pm PST, Mon-Fri)
UK +44 20 8068 2023 (9am-6pm, GMT, Mon-Sat)
DE +49 32221097297 (11am-9pm, CET, Mon-Sat)
FR + 33 176340312 (11am-9pm, CET, Mon-Sat)
IT +39 06 9480 3330 (9am-6pm, CET, Mon-Sat)
ES + 34 931786261 (9am-6pm, CET, Mon-Sat)
AU + 61 2 8310 9897 (11am-7pm, AEST, Mon-Fri)

 **FAQ** avantree.com/support/eon-b

Manufacturer: Avatronics Limited

Address: Luohu District, Shenzhen 518000 China

US Importer:

Avantree Corporation

San Jose, California 95119 USA

UK Importer:

Avantree Limited

Watford, WD180 0HQ UK



Servicer in Europe:

Gizmex GmbH,

Sternstr. 67, 40479 Dusseldorf, Germany

Tel: 01 – 408 334 8648 support@avantree.com



Model No: BTHS-AS100-B
Dispose of the packaging and this product in accordance with the latest provisions.
Z-PKQG-AS100B-V0